

CODIGO DE VIVIENDA **D9**

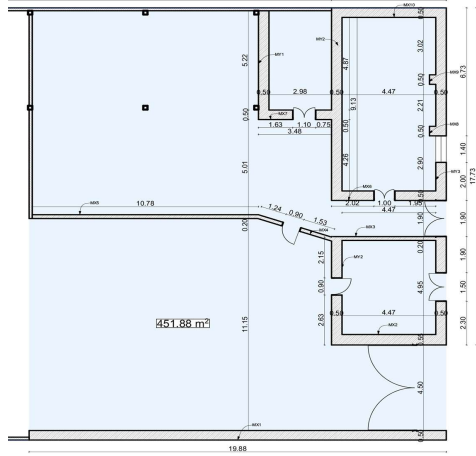

PLANTA

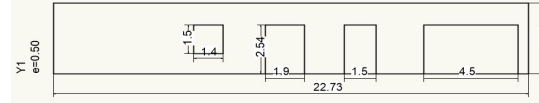

FACHADA



FOTOGRAFÍA

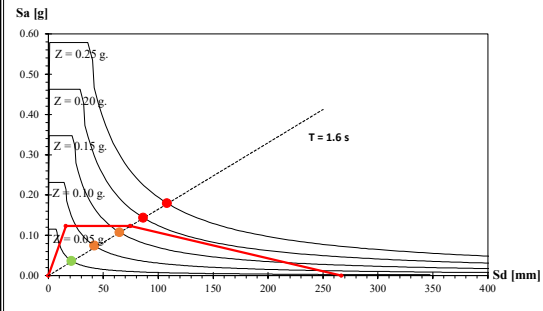

MODO DE FALLA A

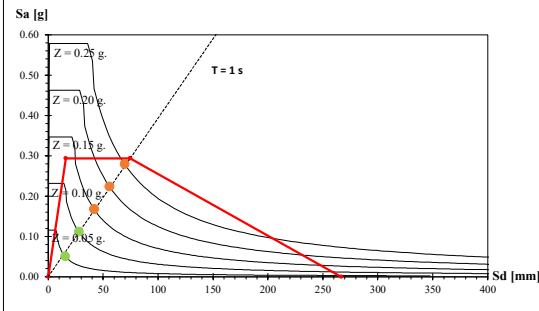

MODO DE FALLA B1

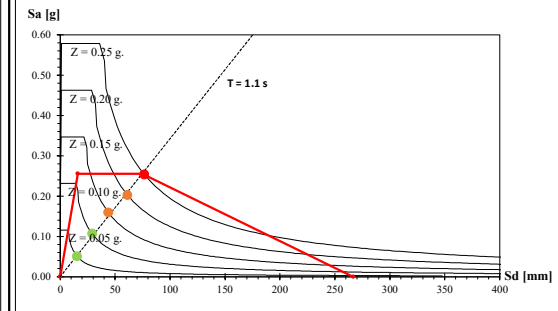

MODO DE FALLA B2

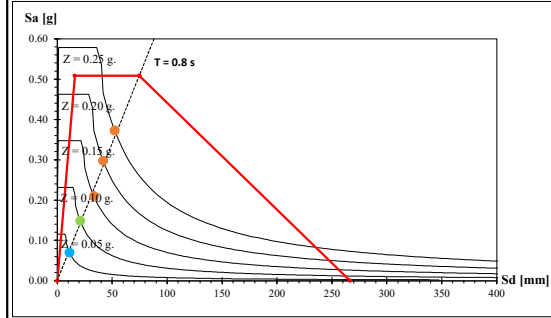

MODO DE FALLA D

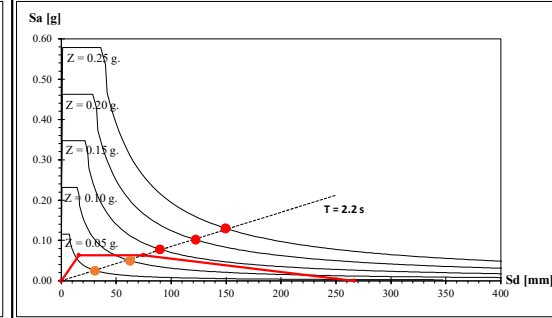

MODO DE FALLA G

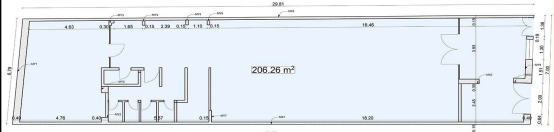

PLANTA

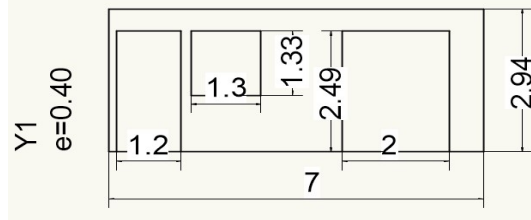

FACHADA



FOTOGRAFÍA

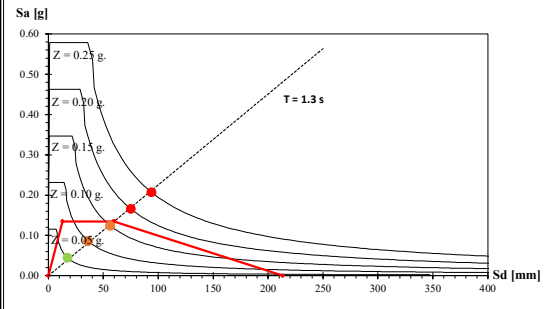

MODO DE FALLA A

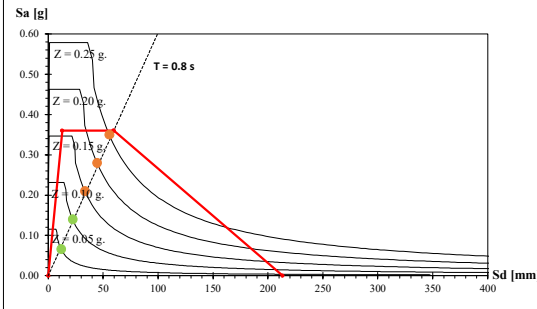

MODO DE FALLA B1

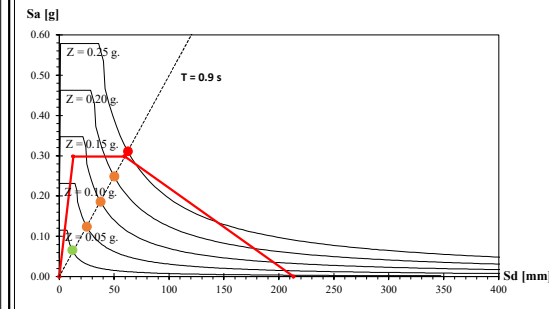

MODO DE FALLA B2

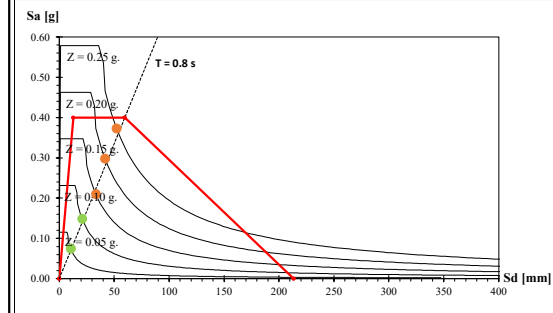

MODO DE FALLA D

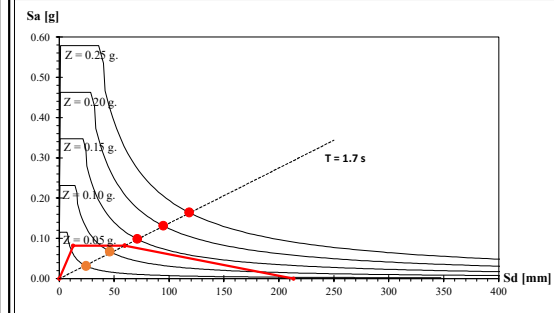

MODO DE FALLA G

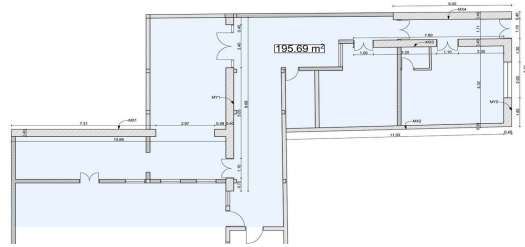

PLANTA

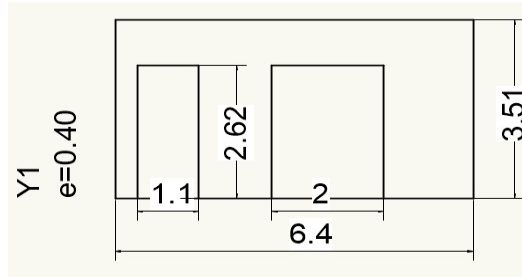

FACHADA



FOTOGRAFÍA

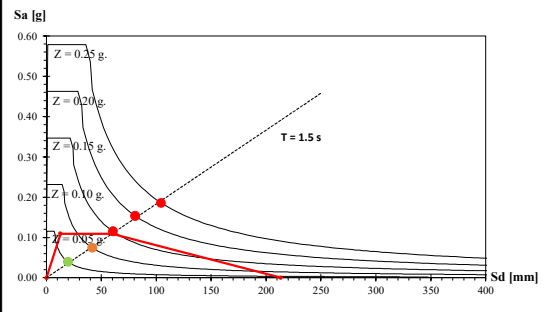

MODO DE FALLA A

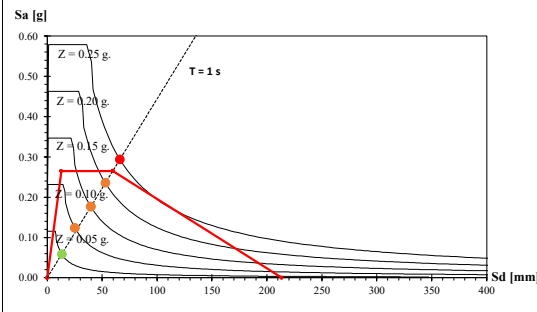

MODO DE FALLA B1

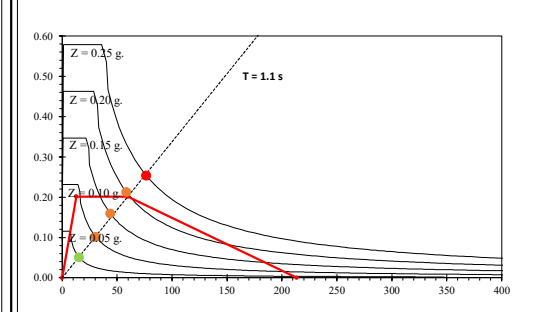

MODO DE FALLA B2

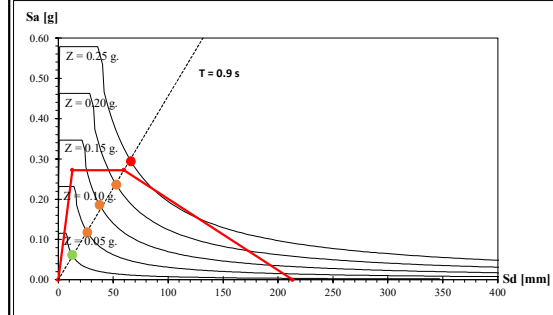

MODO DE FALLA D

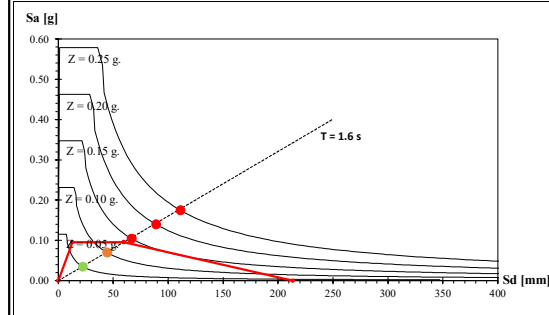

MODO DE FALLA G

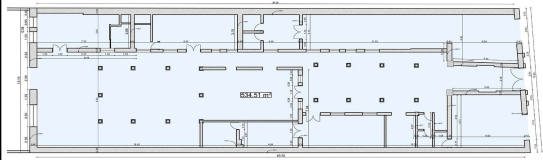

PLANTA

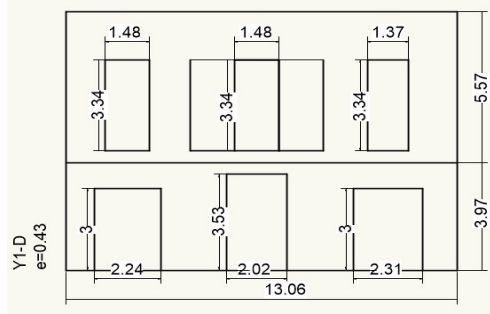

FACHADA



FOTOGRAFÍA

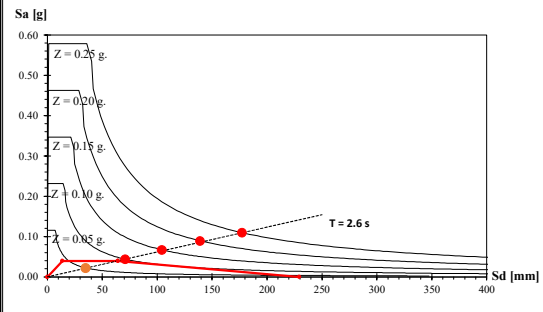

MODO DE FALLA A

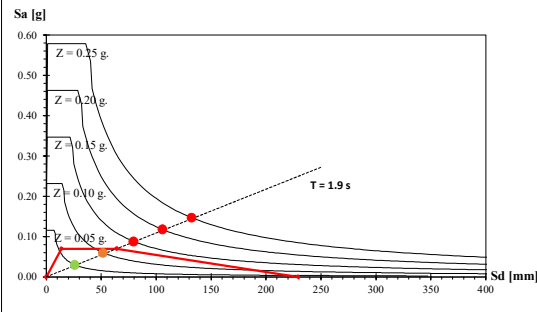

MODO DE FALLA B1

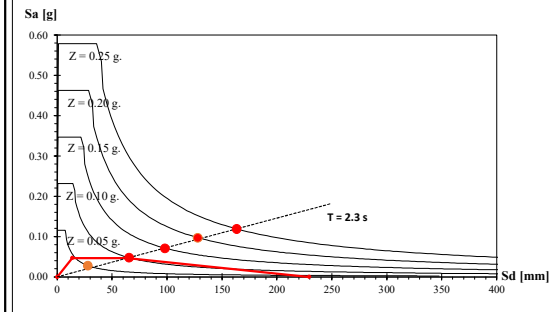

MODO DE FALLA B2

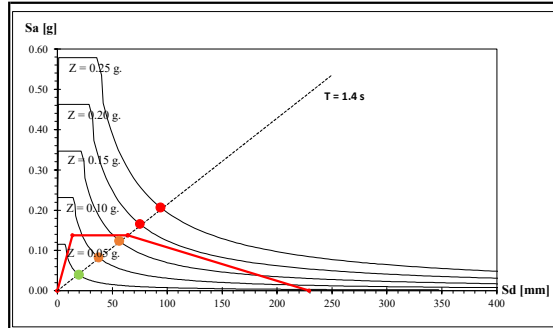

MODO DE FALLA D

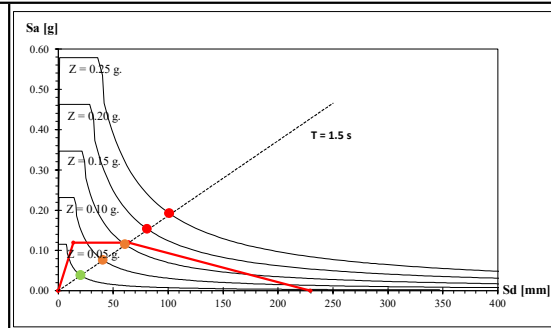

MODO DE FALLA G

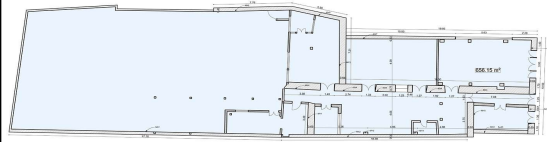

PLANTA

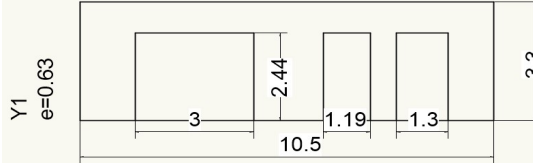

FACHADA



FOTOGRAFÍA

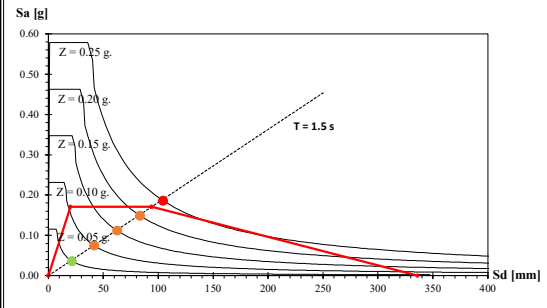

MODO DE FALLA A

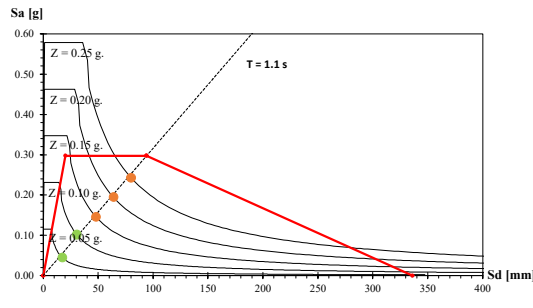

MODO DE FALLA B1

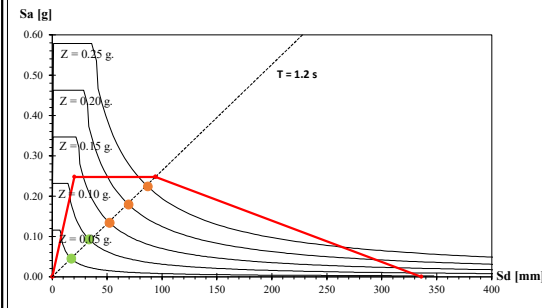

MODO DE FALLA B2

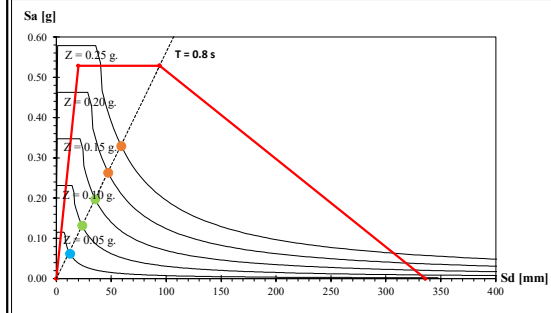

MODO DE FALLA D

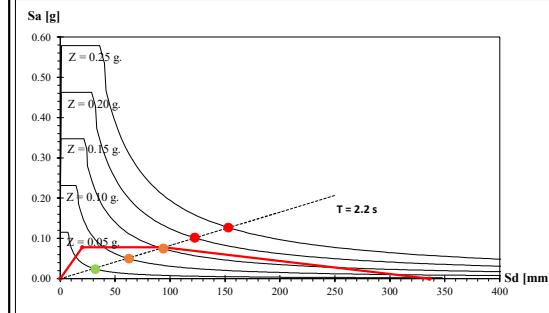

MODO DE FALLA G

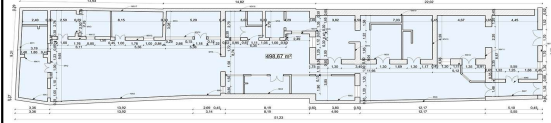

PLANTA

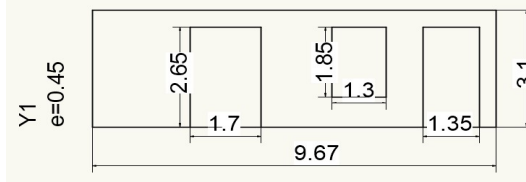

FACHADA



FOTOGRAFÍA

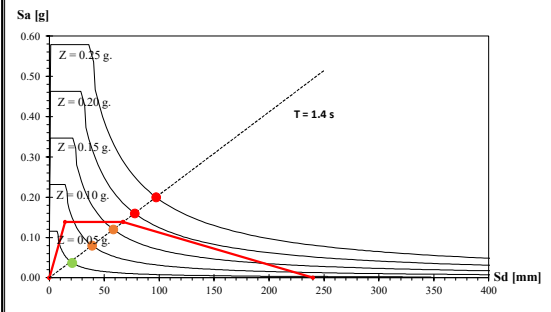

MODO DE FALLA A

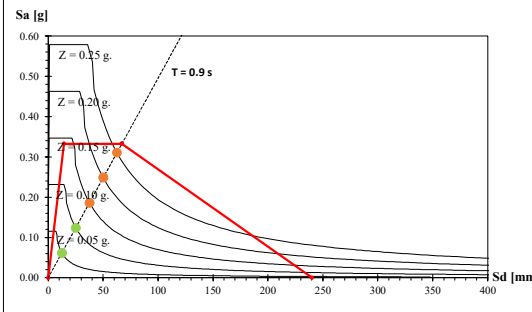

MODO DE FALLA B1

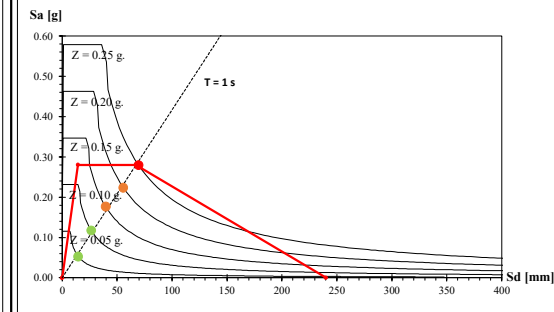

MODO DE FALLA B2

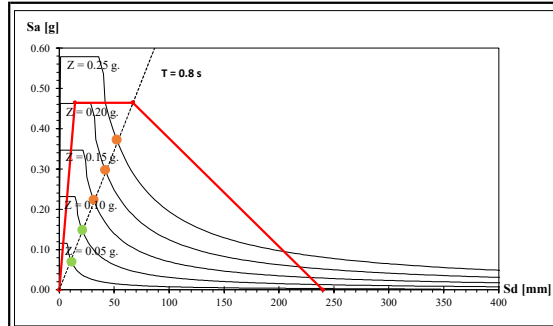

MODO DE FALLA D

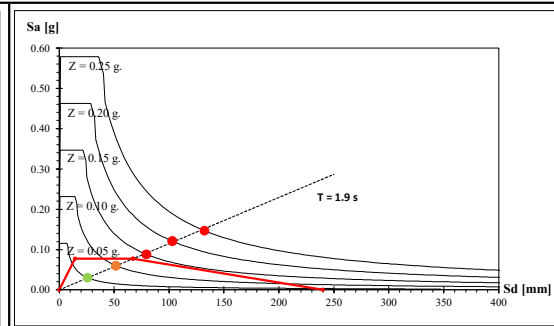

MODO DE FALLA G

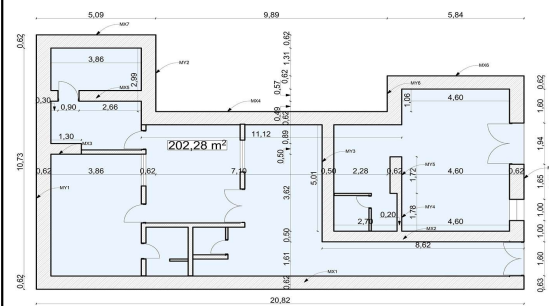

PLANTA

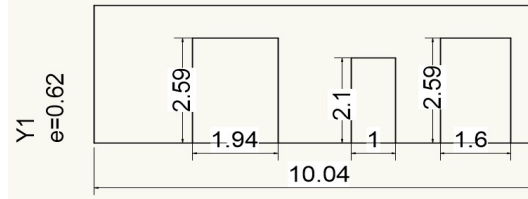

FACHADA



FOTOGRAFÍA

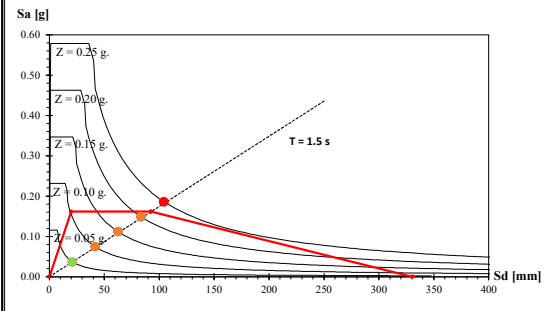

MODO DE FALLA A

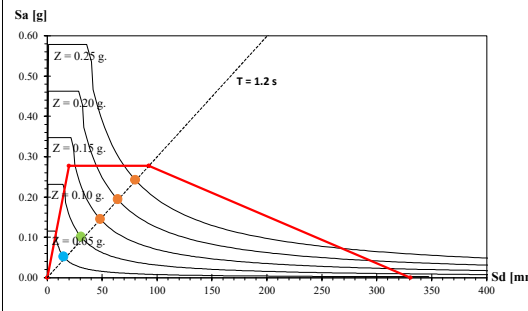

MODO DE FALLA B1

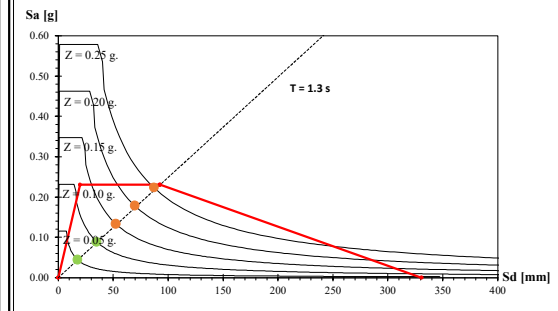

MODO DE FALLA B2

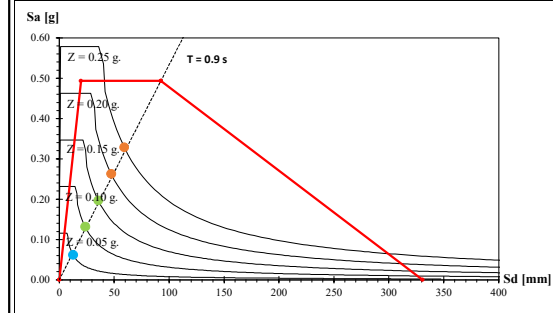

MODO DE FALLA D

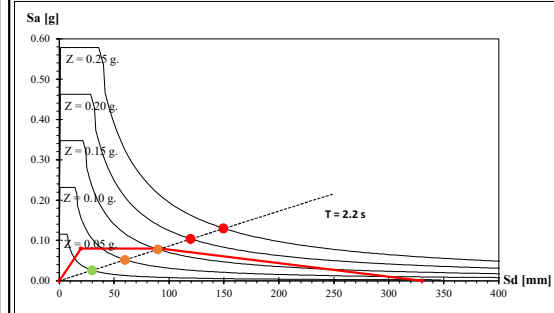

MODO DE FALLA G

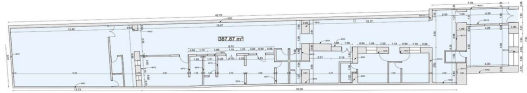

PLANTA

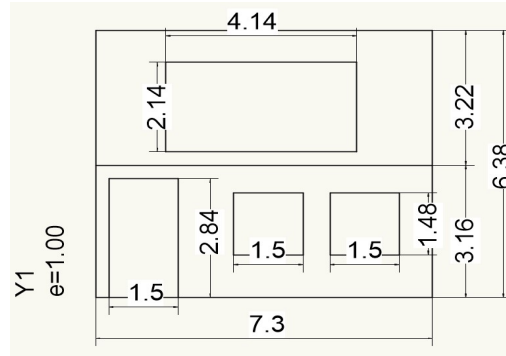

FACHADA



FOTOGRAFÍA

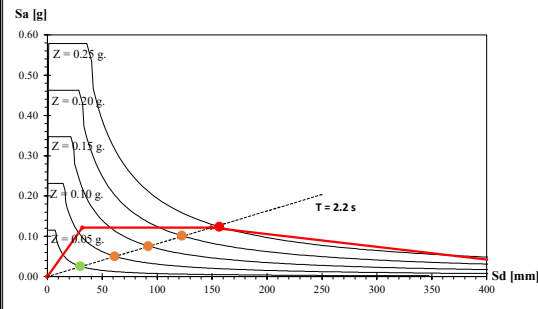

MODO DE FALLA A

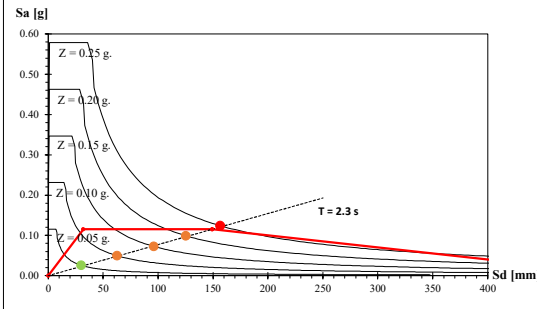

MODO DE FALLA B1

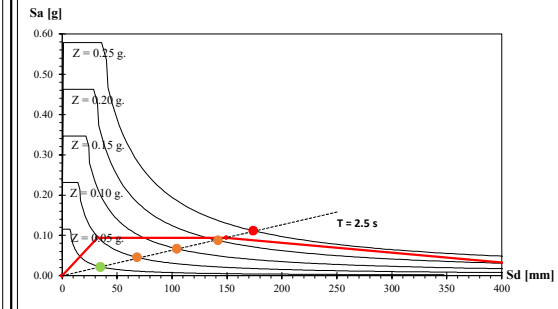

MODO DE FALLA B2

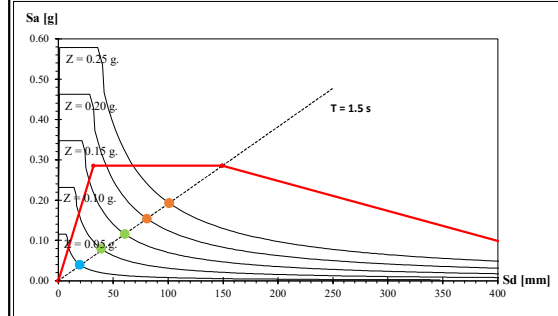

MODO DE FALLA D

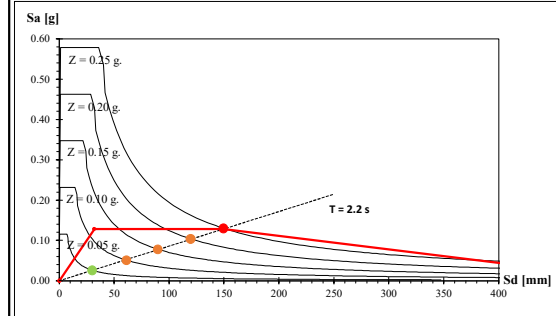

MODO DE FALLA G



PLANTA

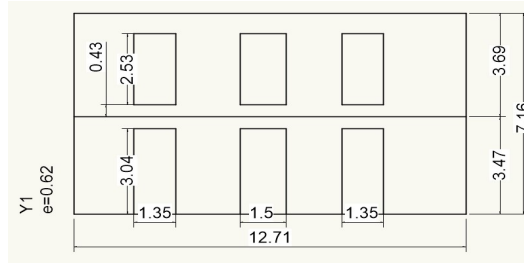

FACHADA



FOTOGRAFÍA

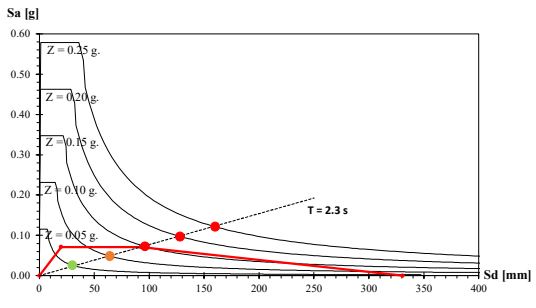

MODO DE FALLA A

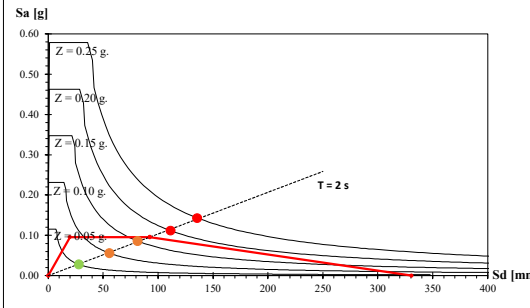

MODO DE FALLA B1

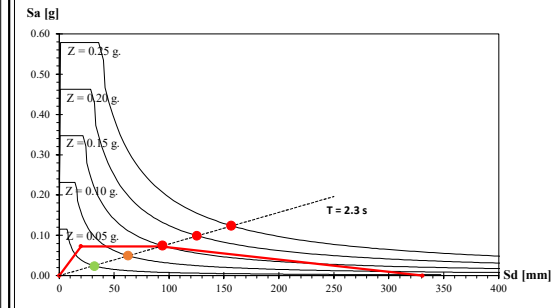

MODO DE FALLA B2

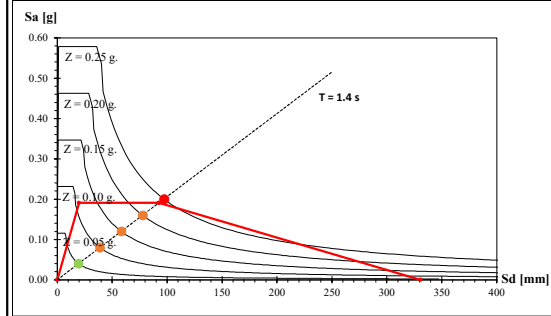

MODO DE FALLA D

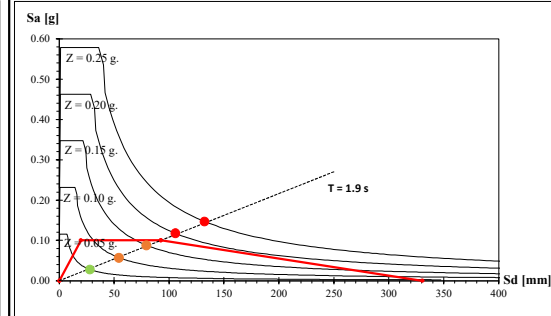

MODO DE FALLA G

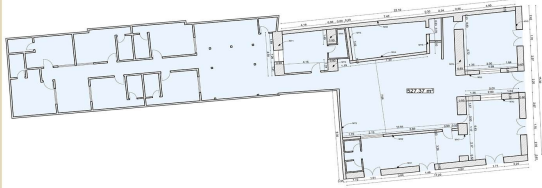

PLANTA

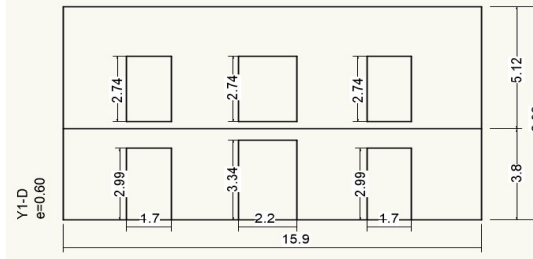

FACHADA



FOTOGRAFÍA

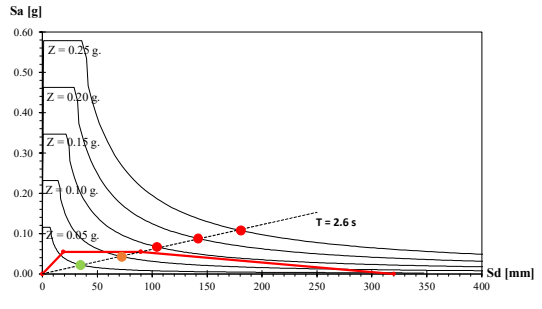

MODO DE FALLA A

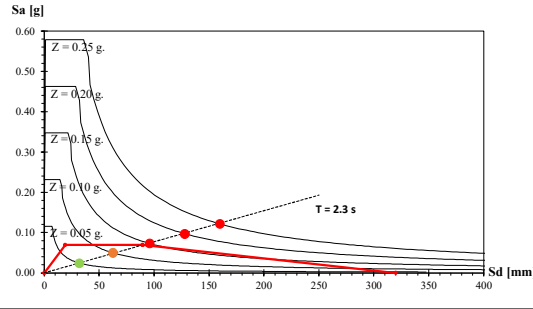

MODO DE FALLA B1

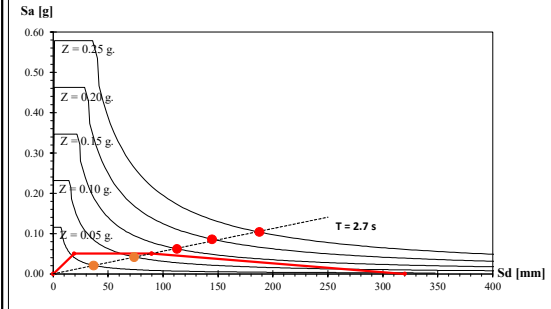

MODO DE FALLA B2

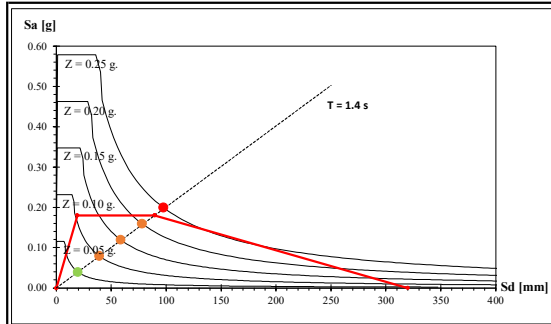

MODO DE FALLA D

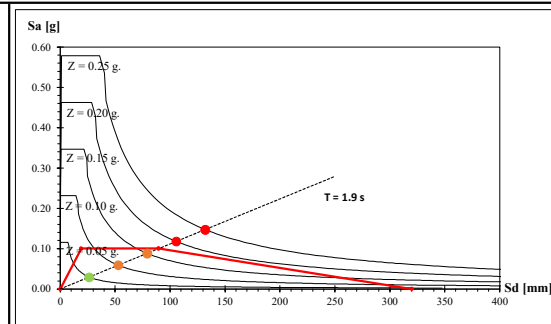

MODO DE FALLA G

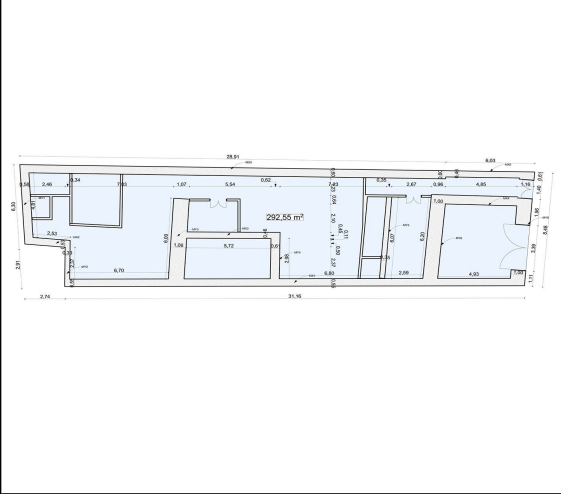

PLANTA

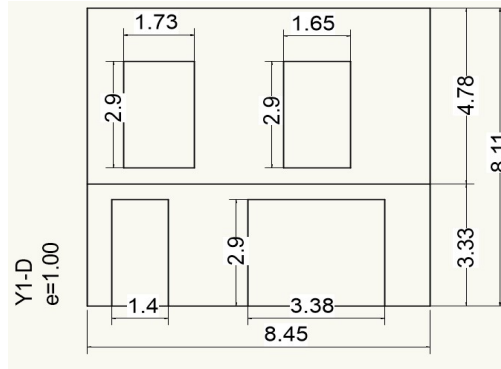

FACHADA



FOTOGRAFÍA

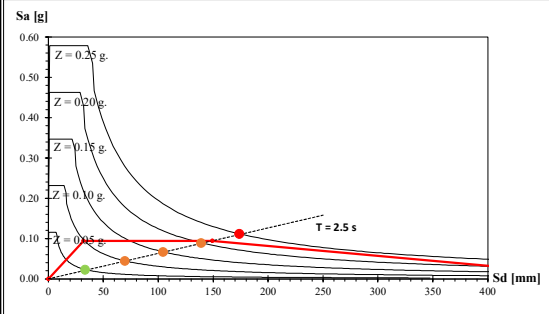

MODO DE FALLA A

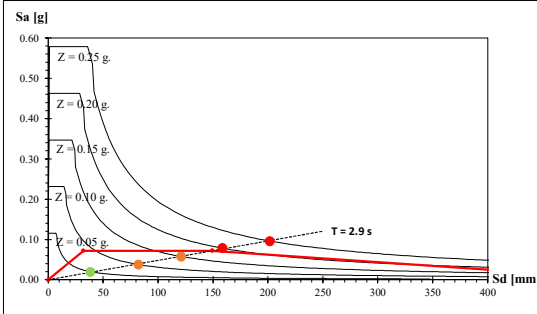

MODO DE FALLA B1

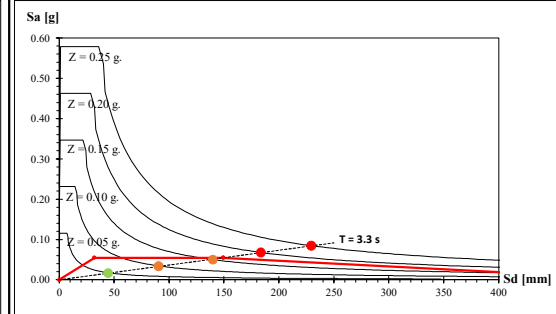

MODO DE FALLA B2

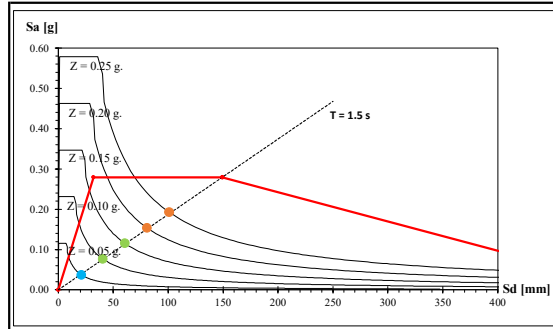

MODO DE FALLA D

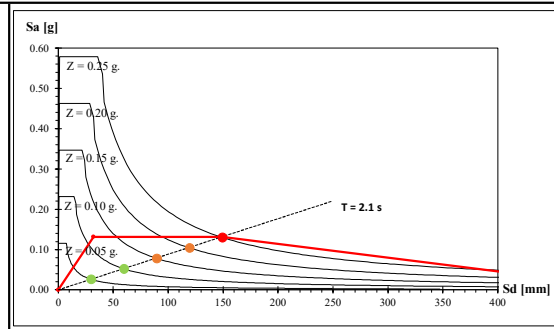

MODO DE FALLA G

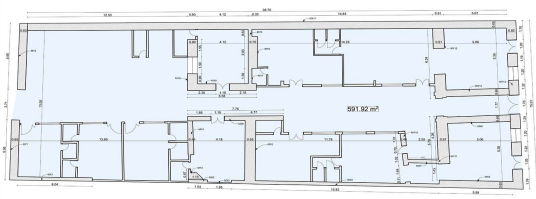

PLANTA

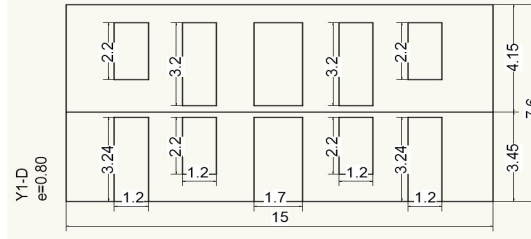

FACHADA



FOTOGRAFÍA

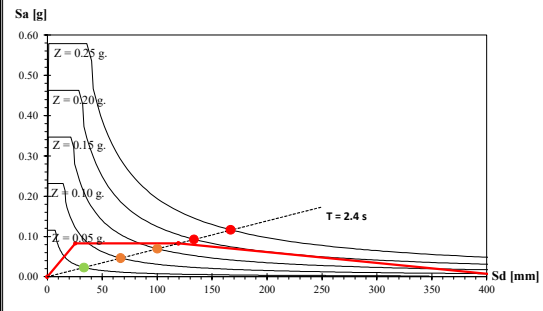

MODO DE FALLA A

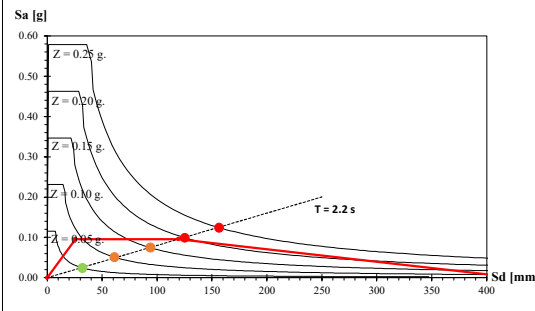

MODO DE FALLA B1

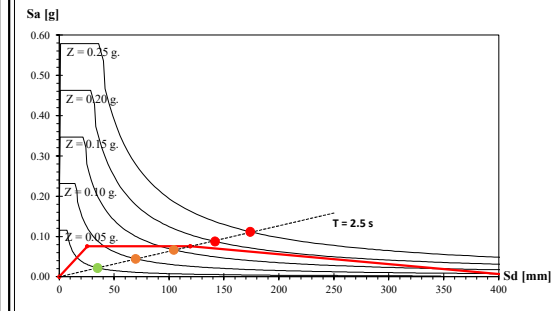

MODO DE FALLA B2

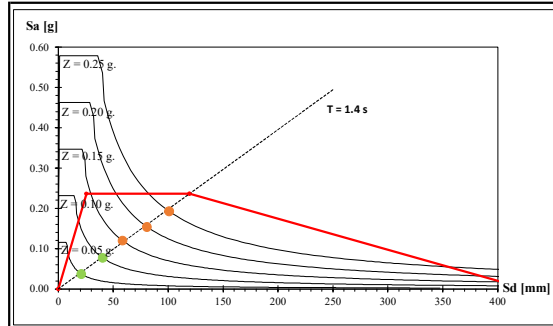

MODO DE FALLA D

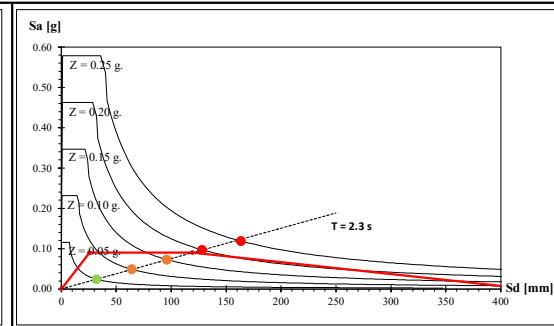

MODO DE FALLA G

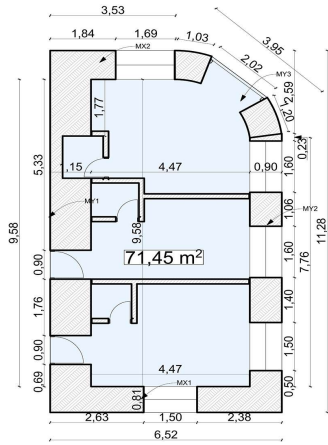

PLANTA

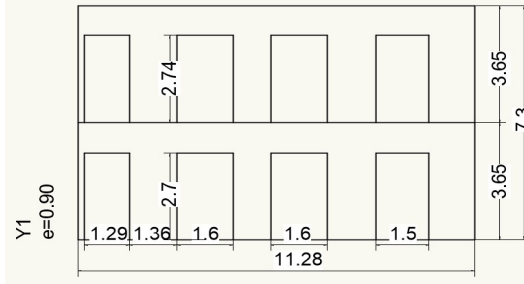

FACHADA



FOTOGRAFÍA

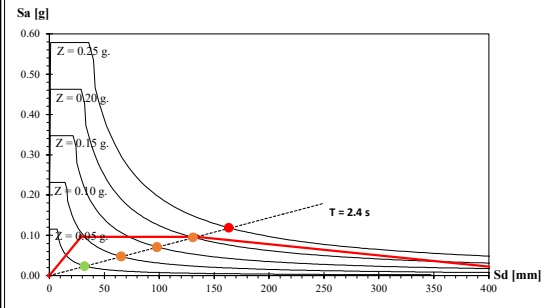

MODO DE FALLA A

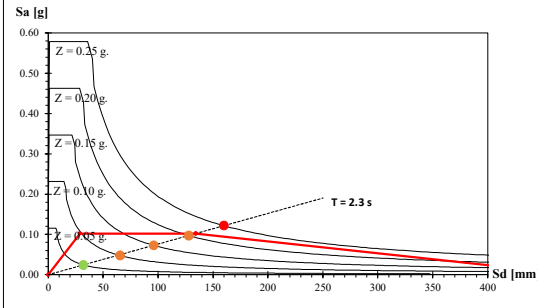

MODO DE FALLA B1

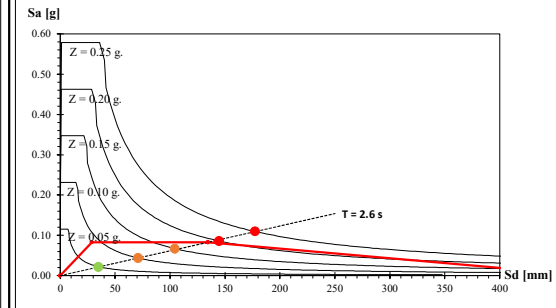

MODO DE FALLA B2

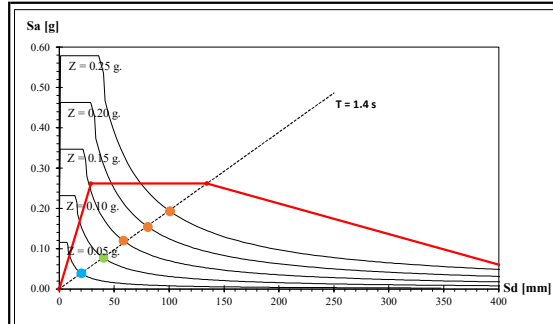

MODO DE FALLA D

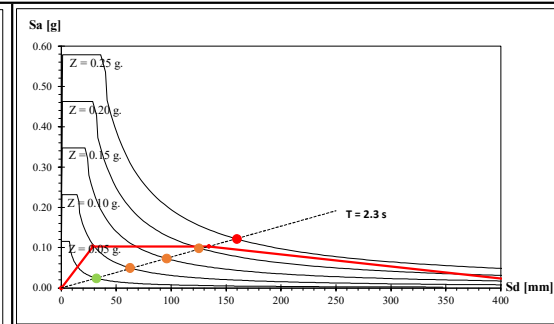

MODO DE FALLA G

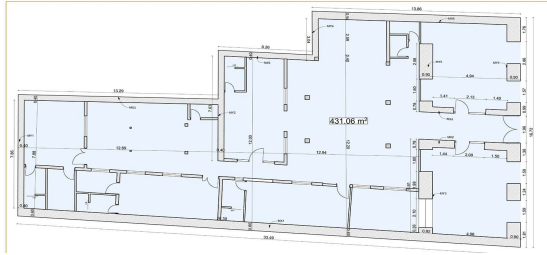

PLANTA

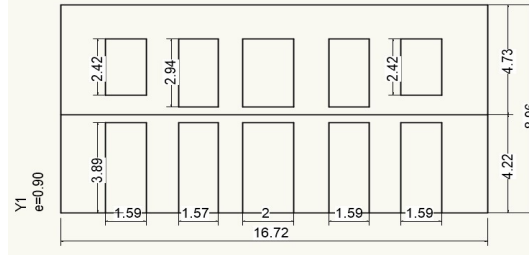

FACHADA



FOTOGRAFÍA

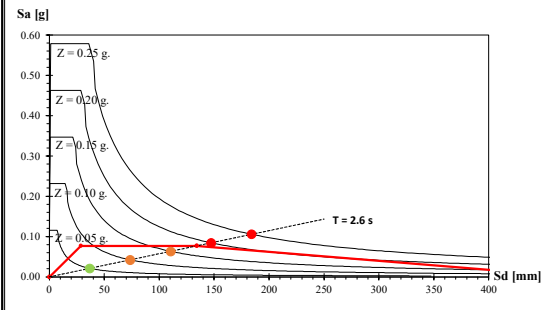

MODO DE FALLA A

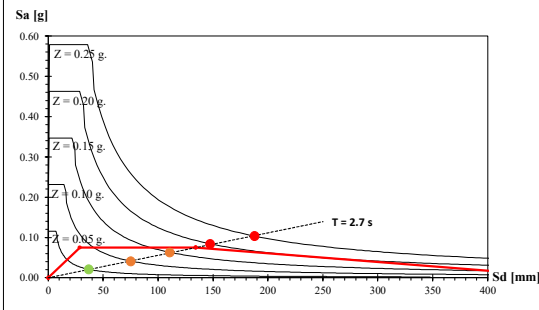

MODO DE FALLA B1

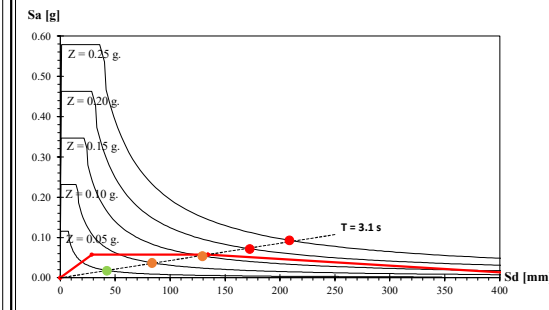

MODO DE FALLA B2

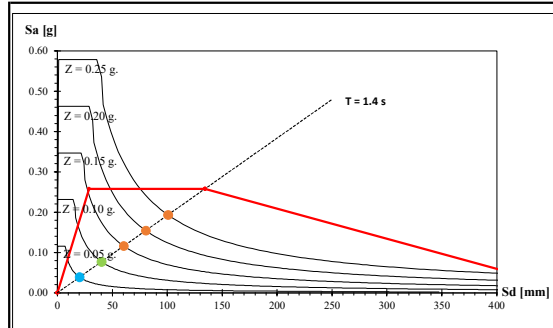

MODO DE FALLA D

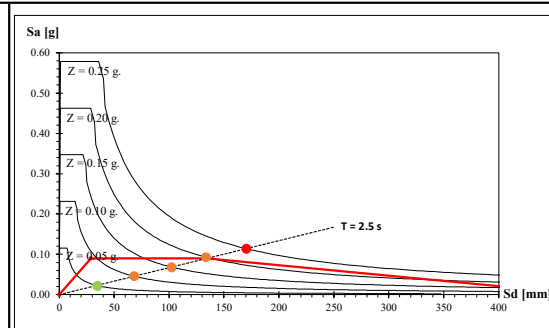

MODO DE FALLA G

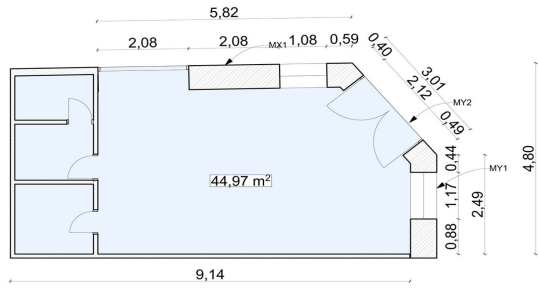

PLANTA

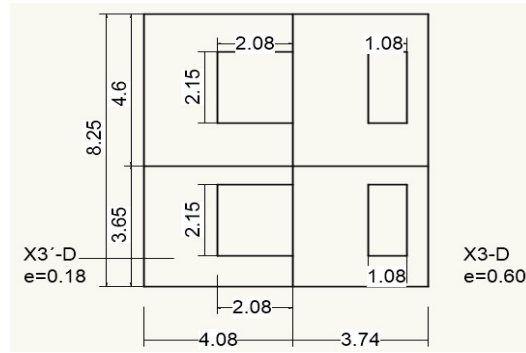

FACHADA

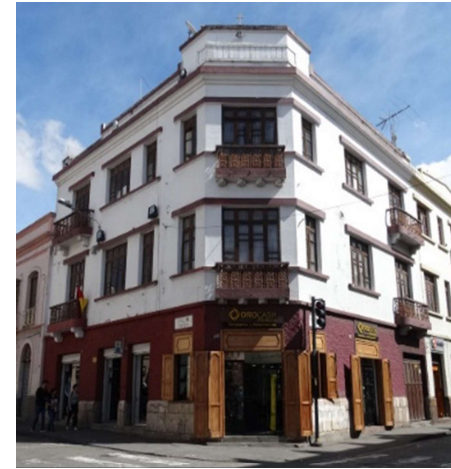

FOTOGRAFÍA

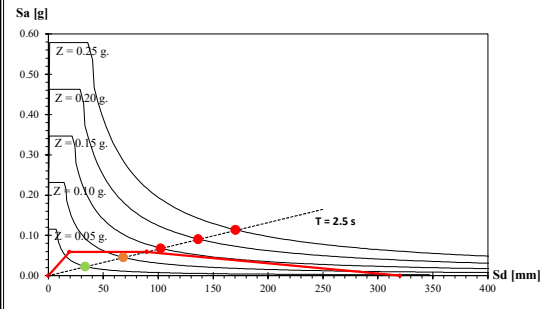

MODO DE FALLA A

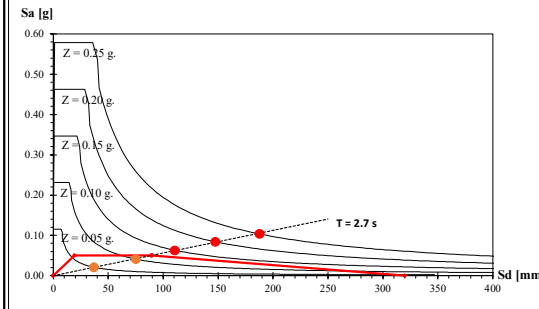

MODO DE FALLA B1

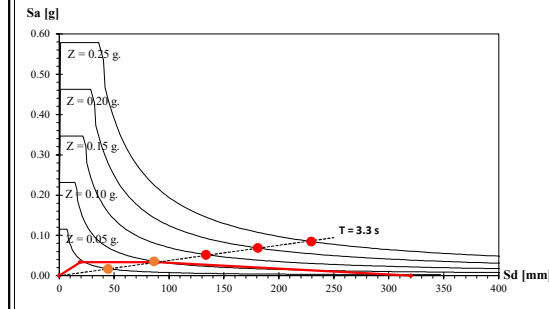

MODO DE FALLA B2

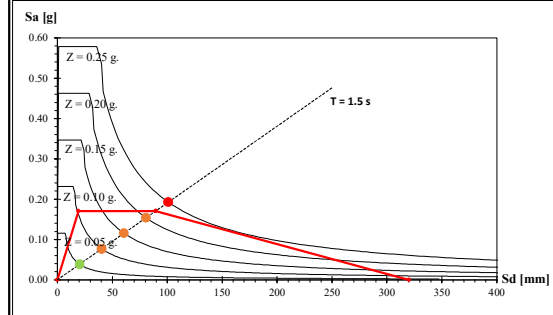

MODO DE FALLA D

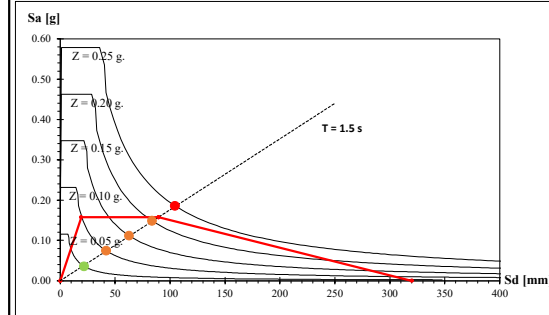

MODO DE FALLA G

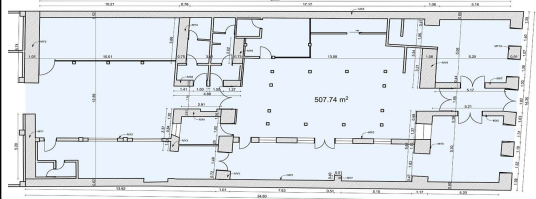

PLANTA

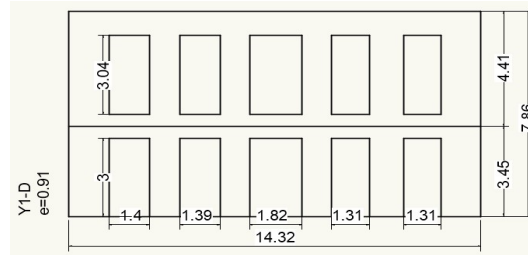

FACHADA



FOTOGRAFÍA

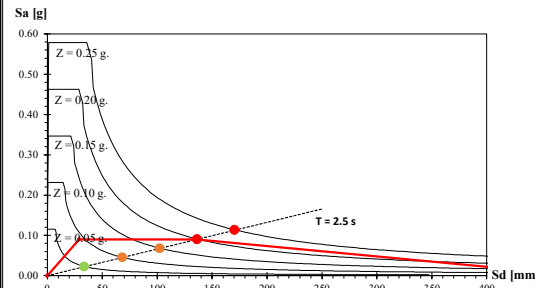

MODO DE FALLA A

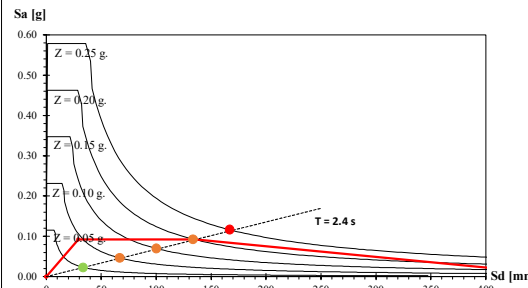

MODO DE FALLA B1

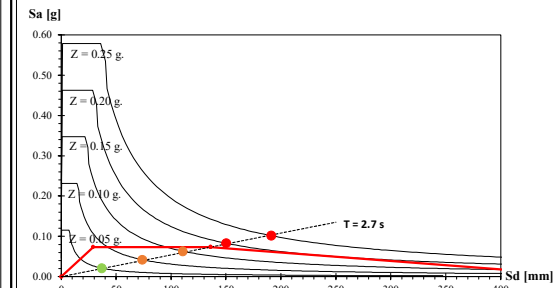

MODO DE FALLA B2

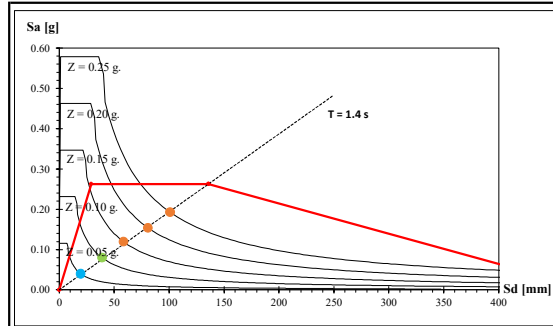

MODO DE FALLA D

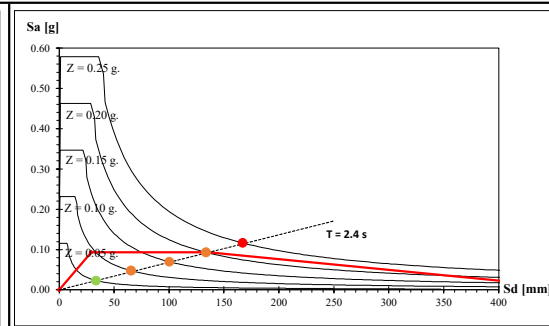

MODO DE FALLA G



PLANTA

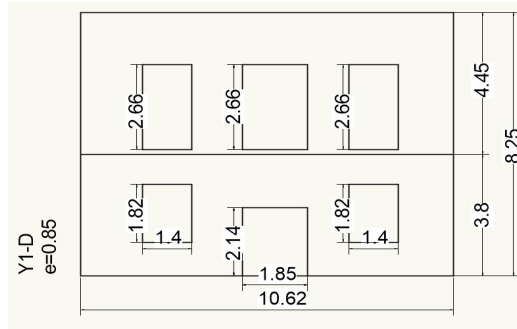

FACHADA



FOTOGRAFÍA

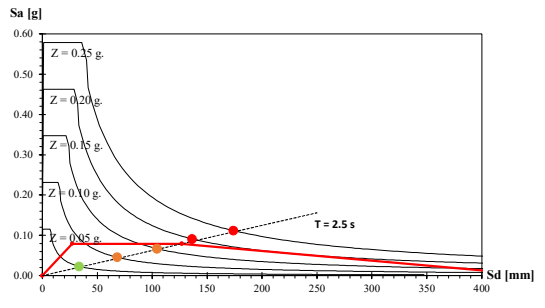

MODO DE FALLA A

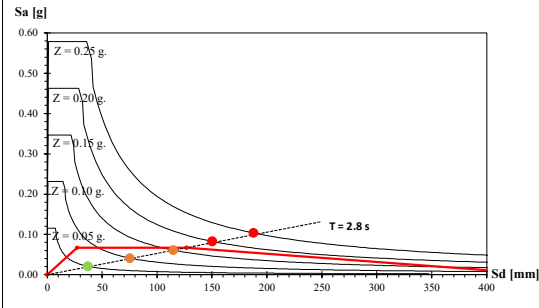

MODO DE FALLA B1

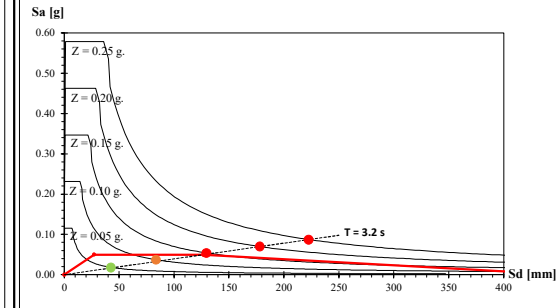

MODO DE FALLA B2

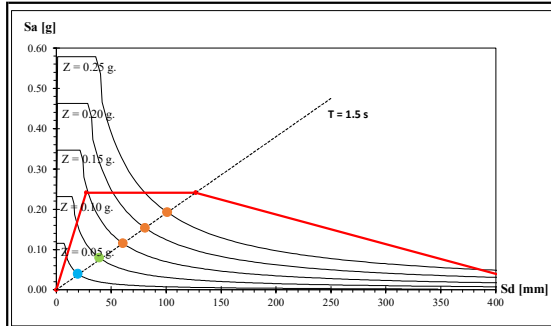

MODO DE FALLA D

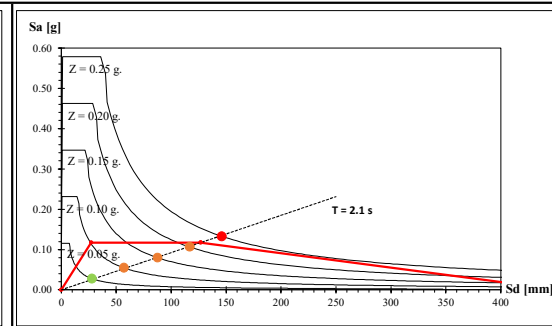

MODO DE FALLA G

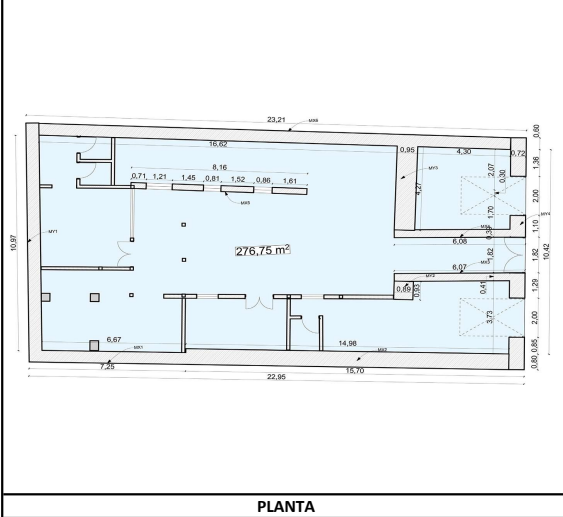

PLANTA

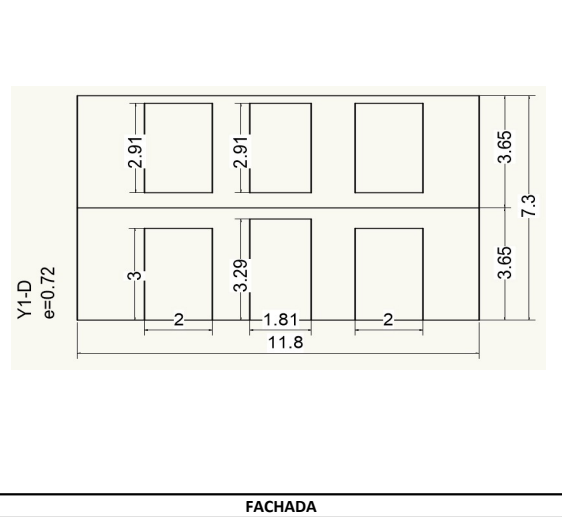

FACHADA



FOTOGRAFÍA

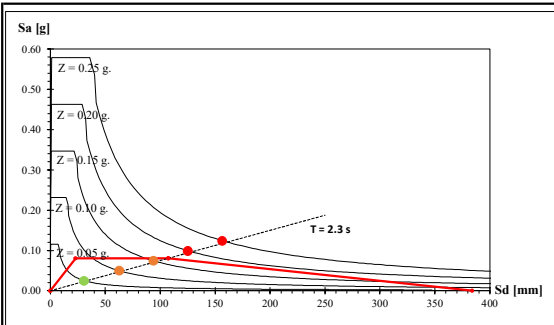

MODO DE FALLA A

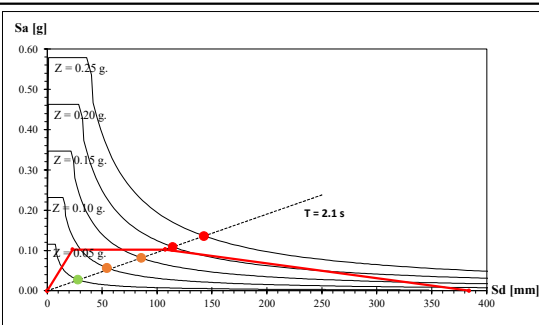

MODO DE FALLA B1

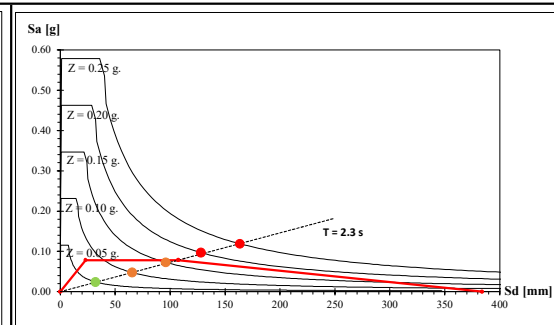

MODO DE FALLA B2

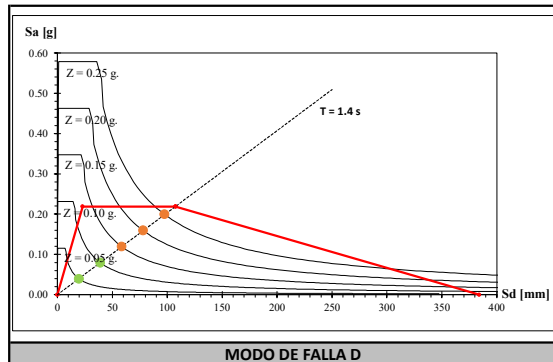

MODO DE FALLA D

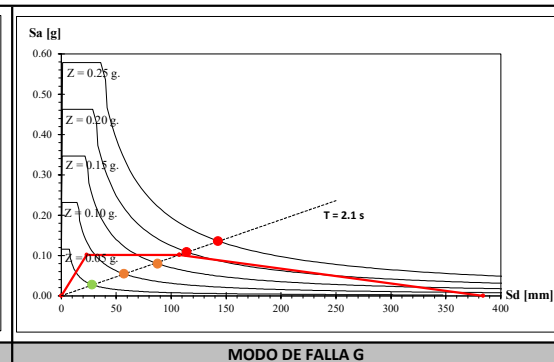

MODO DE FALLA G

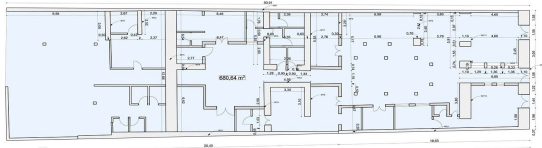

PLANTA

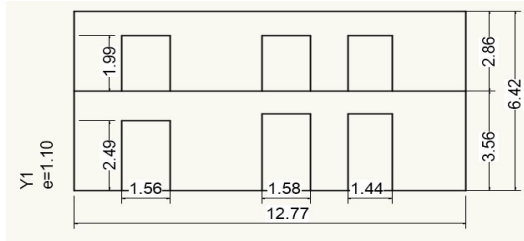

FACHADA



FOTOGRAFÍA

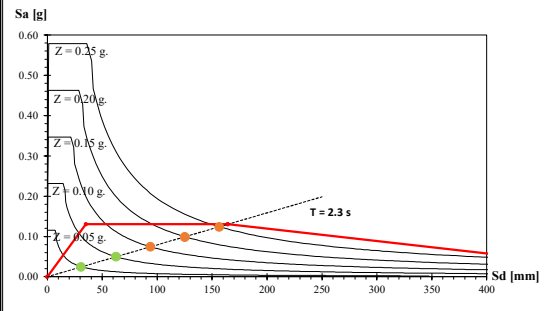

MODO DE FALLA A

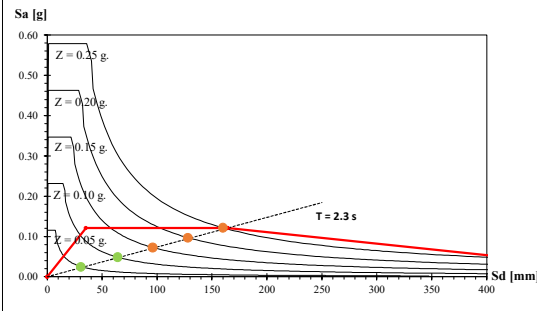

MODO DE FALLA B1

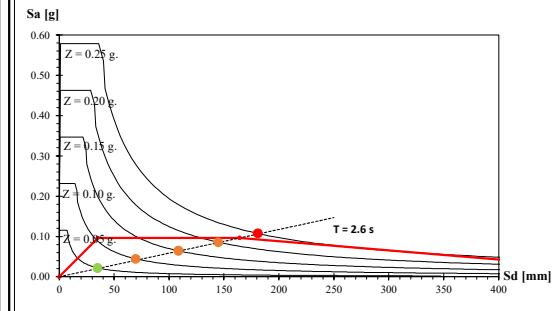

MODO DE FALLA B2

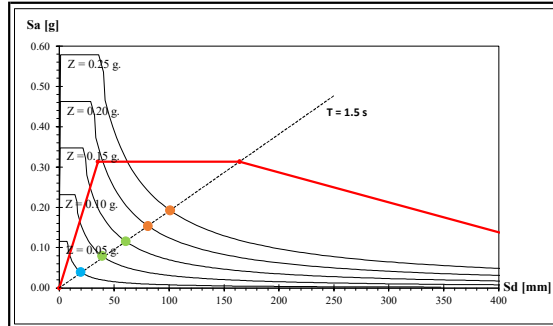

MODO DE FALLA D

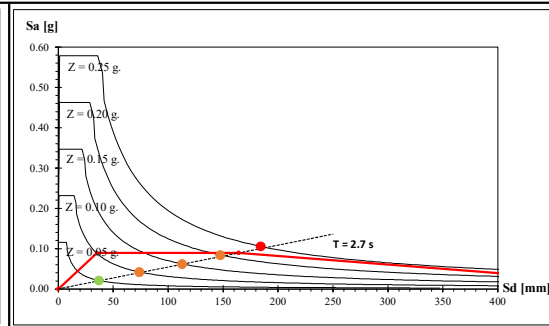

MODO DE FALLA G

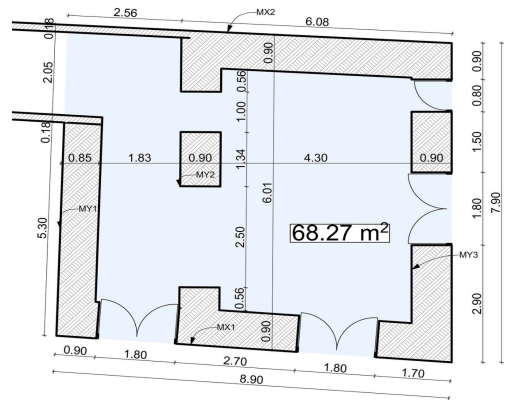

PLANTA

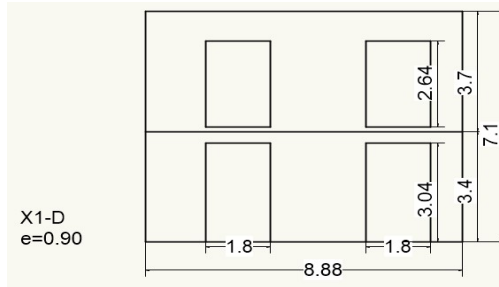

FACHADA



FOTOGRAFÍA

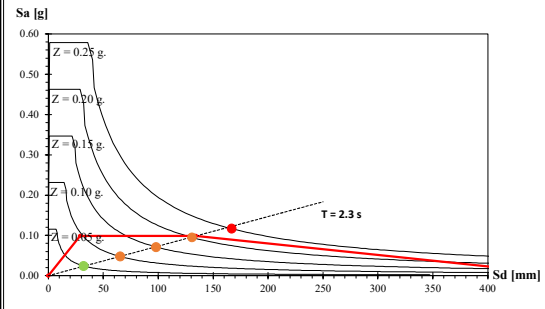

MODO DE FALLA A

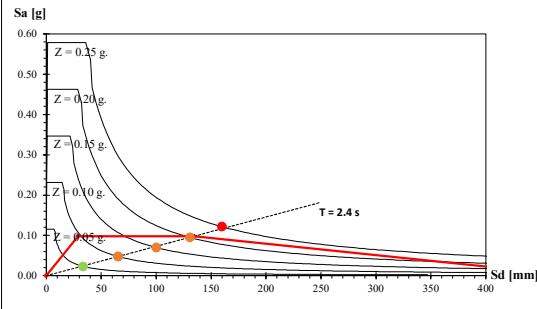

MODO DE FALLA B1

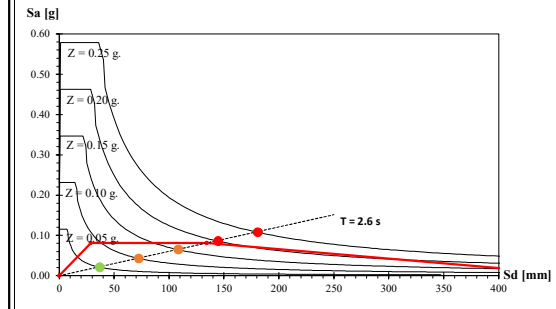

MODO DE FALLA B2

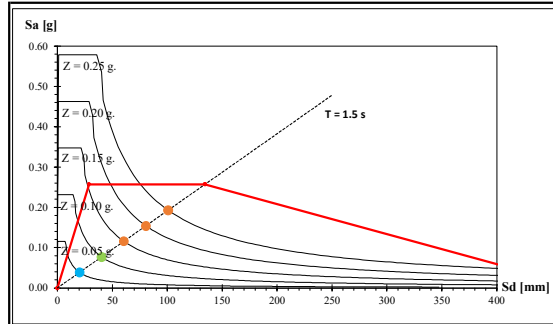

MODO DE FALLA D

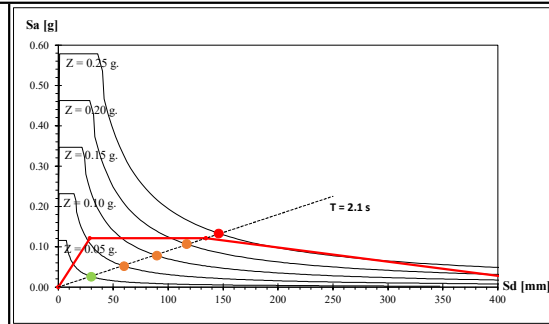

MODO DE FALLA G

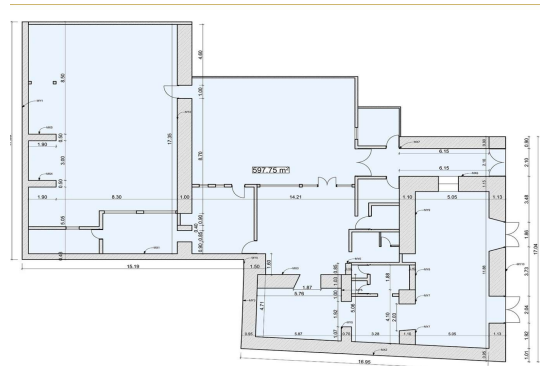

PLANTA

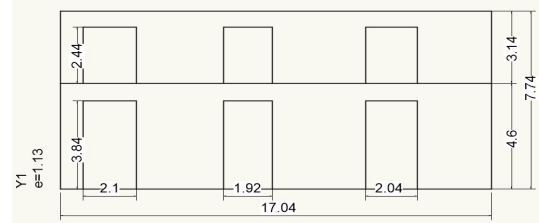

FACHADA



FOTOGRAFÍA

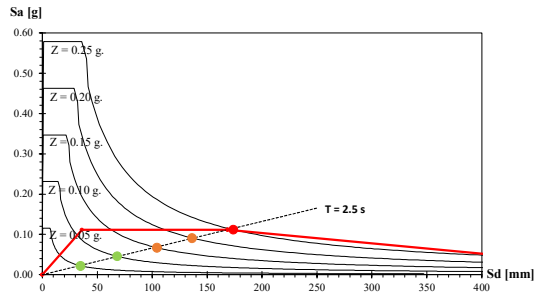

MODO DE FALLA A

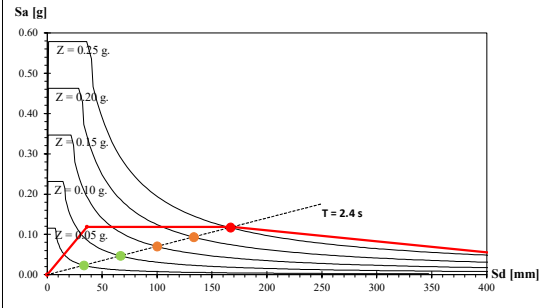

MODO DE FALLA B1

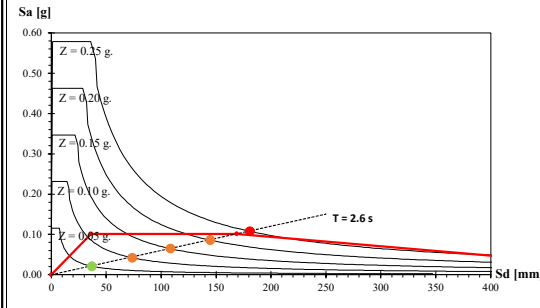

MODO DE FALLA B2

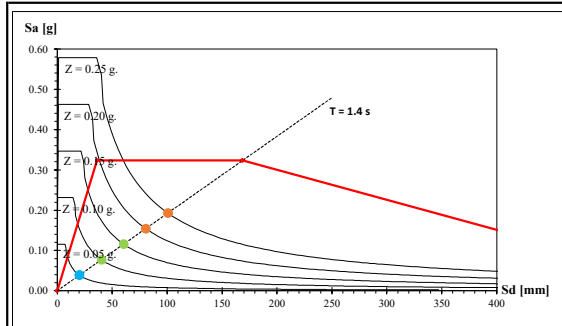

MODO DE FALLA D

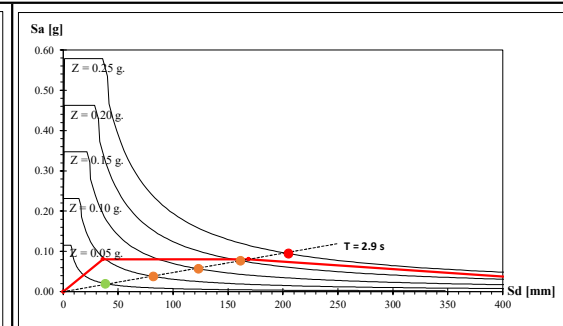

MODO DE FALLA G

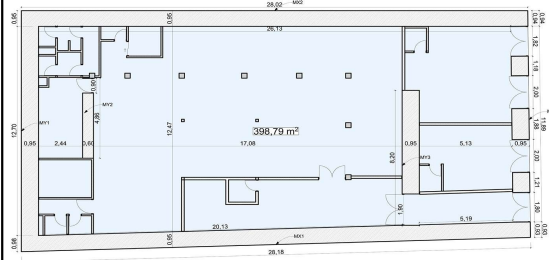

PLANTA

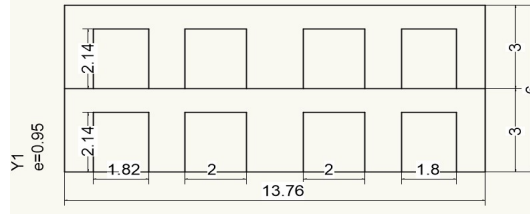

FACHADA



FOTOGRAFÍA

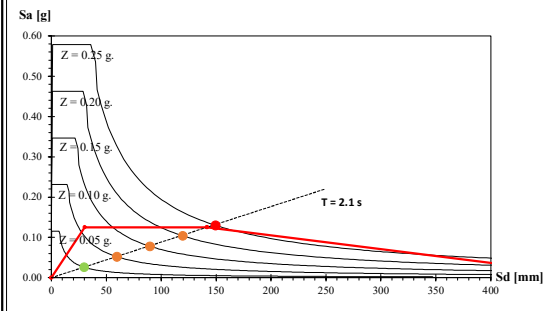

MODO DE FALLA A

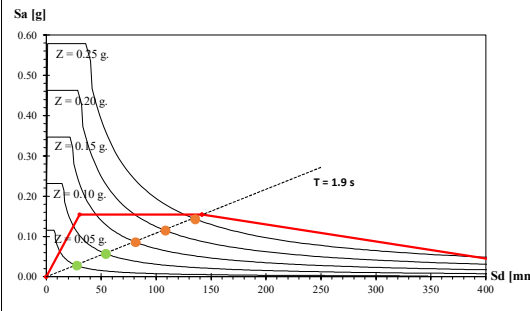

MODO DE FALLA B1

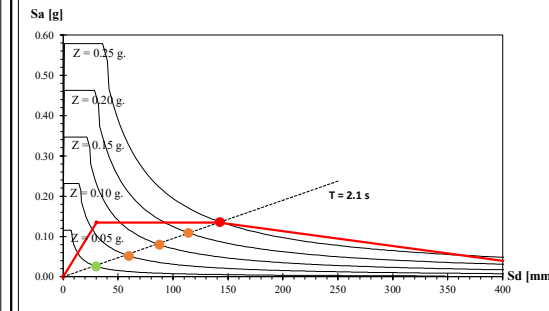

MODO DE FALLA B2

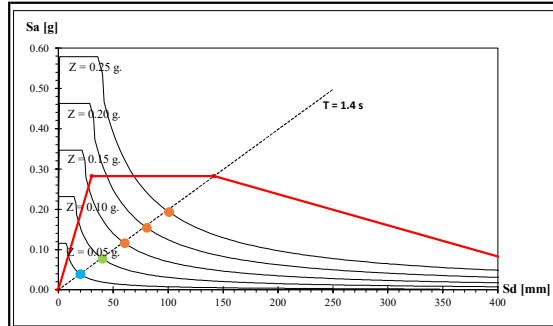

MODO DE FALLA D

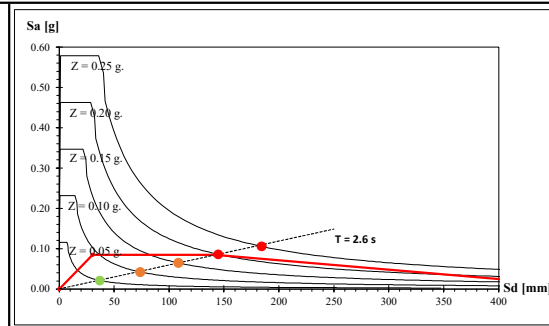

MODO DE FALLA G

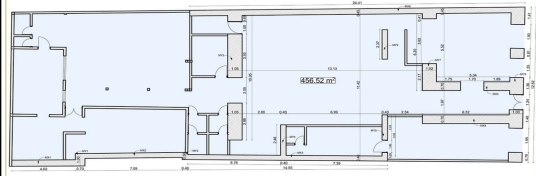

PLANTA

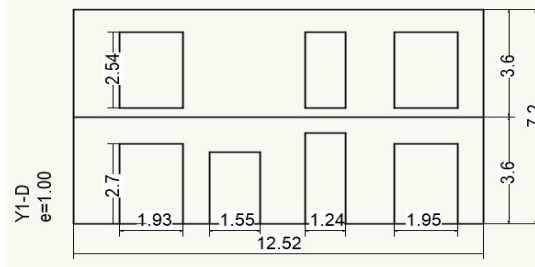

Y1-D
e=1.00

FACHADA



FOTOGRAFÍA

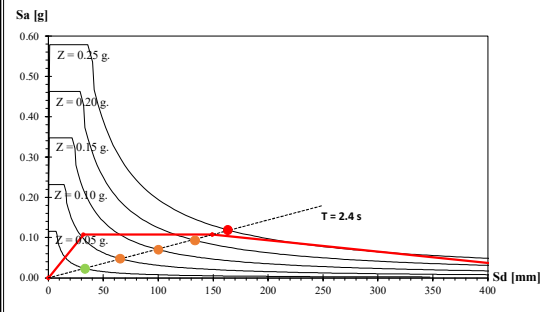

MODO DE FALLA A

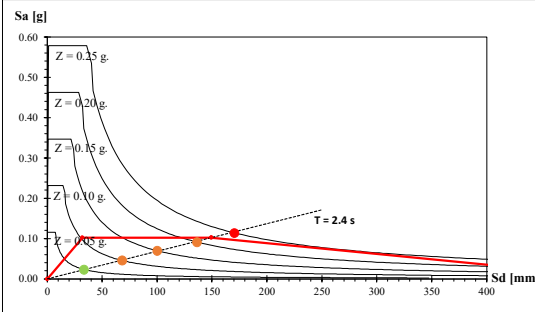

MODO DE FALLA B1

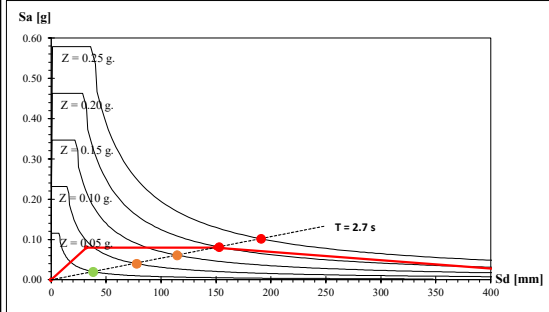

MODO DE FALLA B2

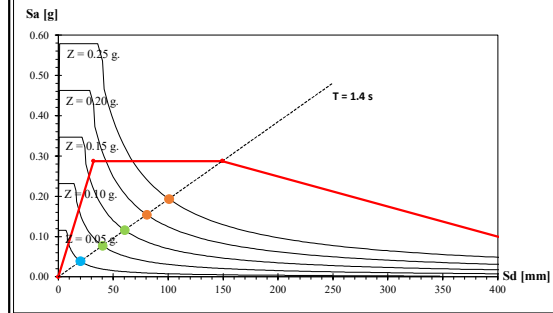

MODO DE FALLA D

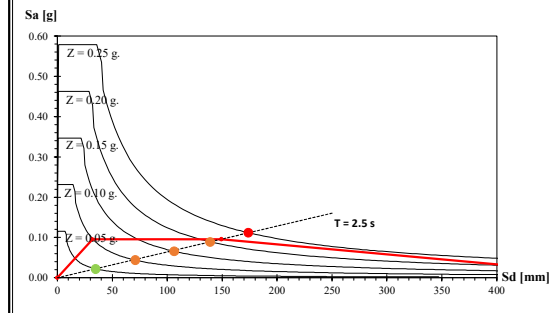

MODO DE FALLA G

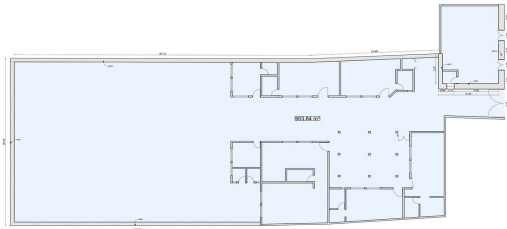

PLANTA

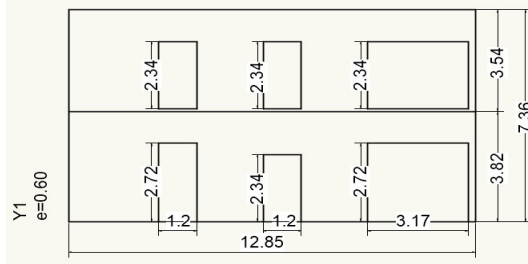

FACHADA



FOTOGRAFÍA

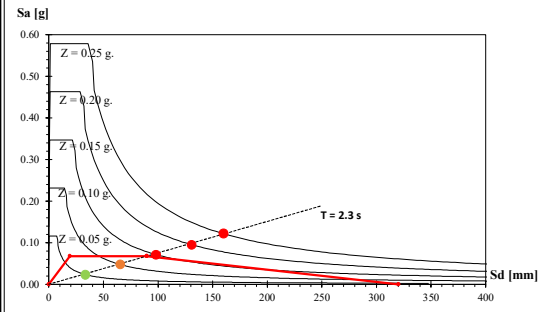

MODO DE FALLA A

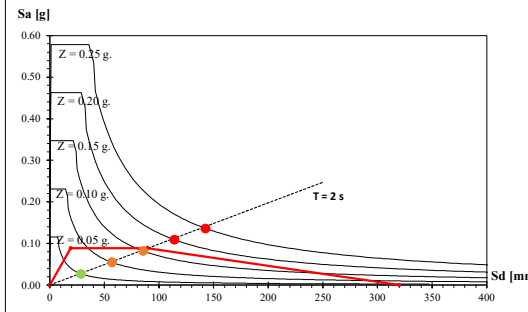

MODO DE FALLA B1

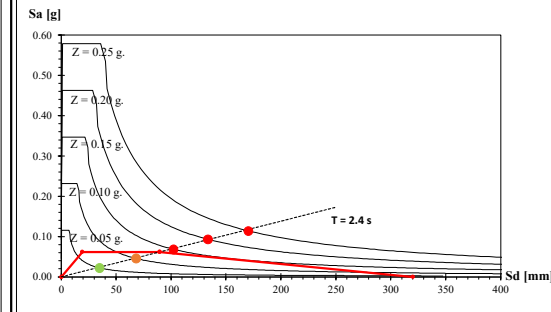

MODO DE FALLA B2

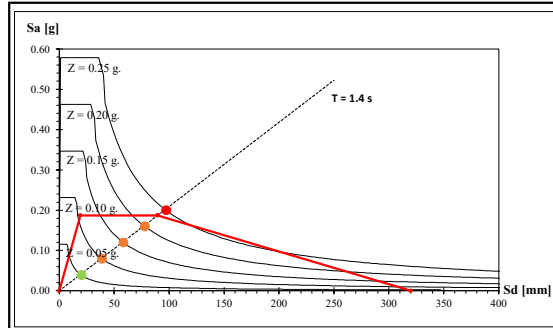

MODO DE FALLA D

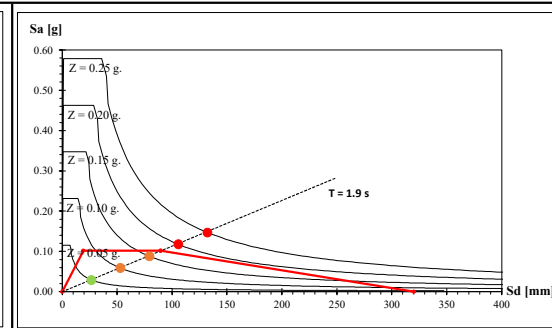

MODO DE FALLA G

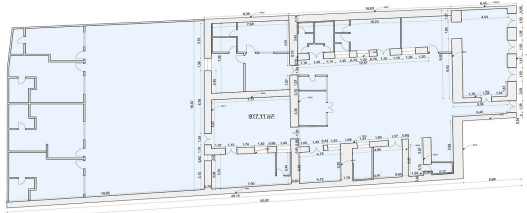

PLANTA

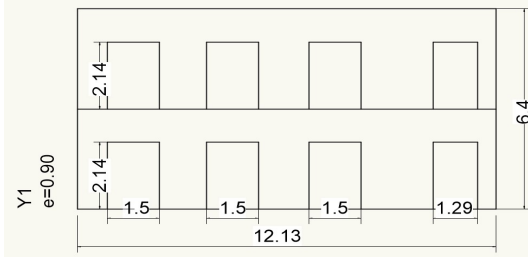

FACHADA



FOTOGRAFÍA

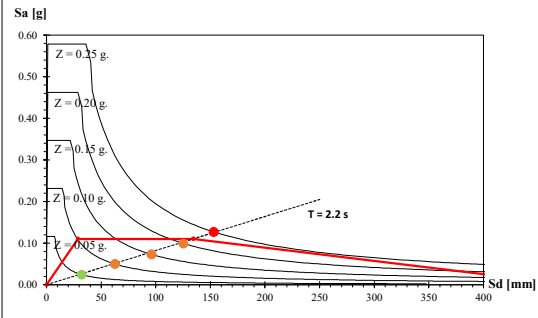

MODO DE FALLA A

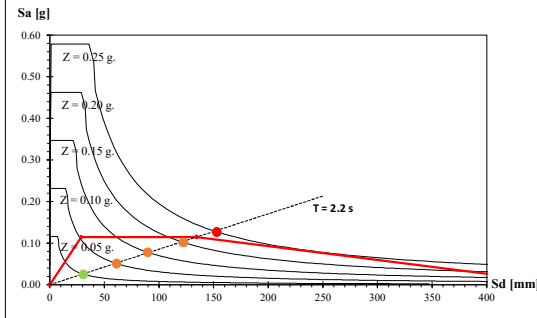

MODO DE FALLA B1

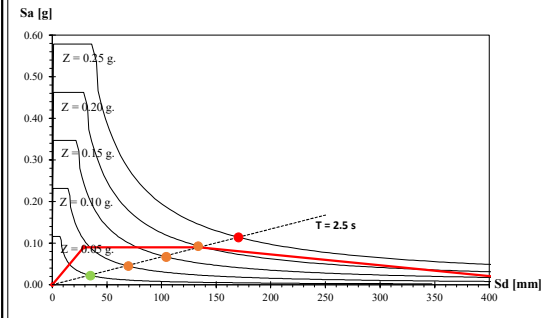

MODO DE FALLA B2

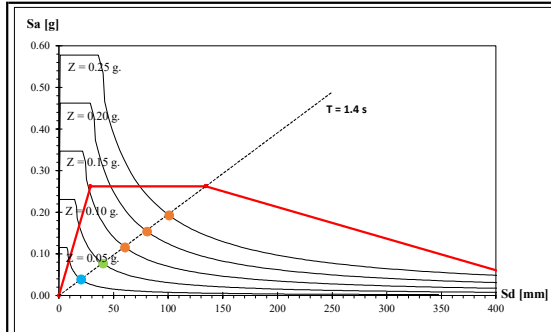

MODO DE FALLA D

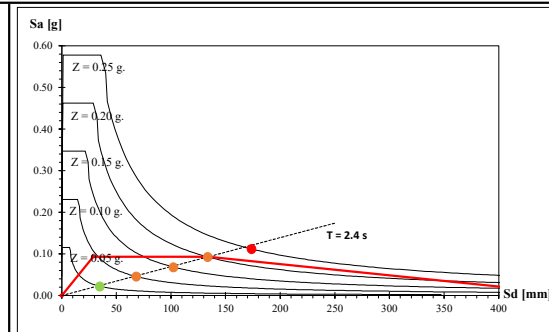

MODO DE FALLA G

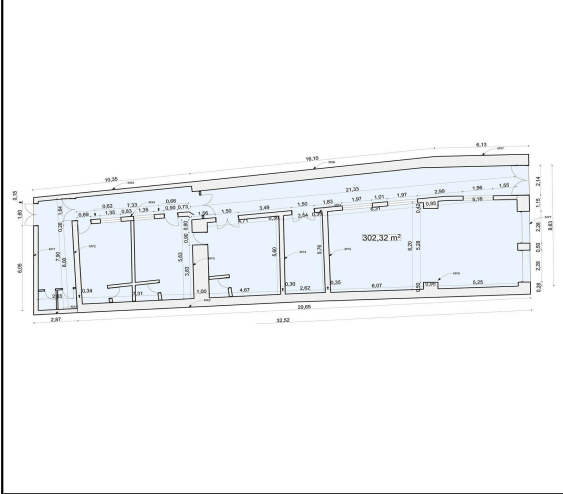

PLANTA

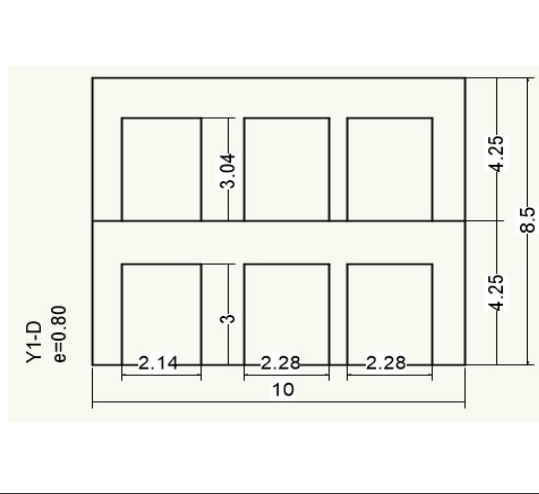

FACHADA



FOTOGRAFÍA

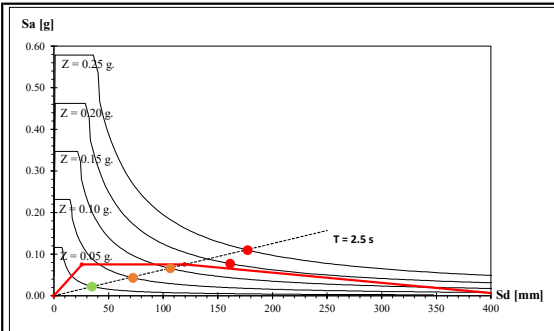

MODO DE FALLA A

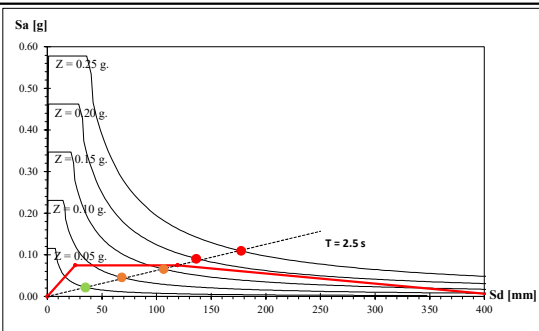

MODO DE FALLA B1

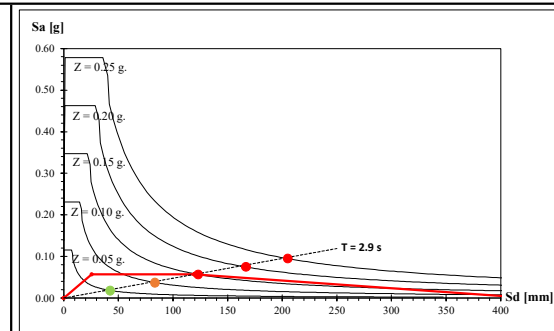

MODO DE FALLA B2

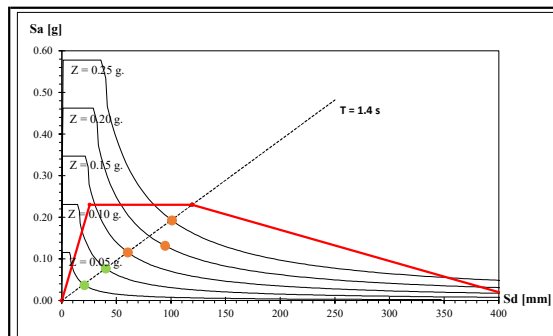

MODO DE FALLA D

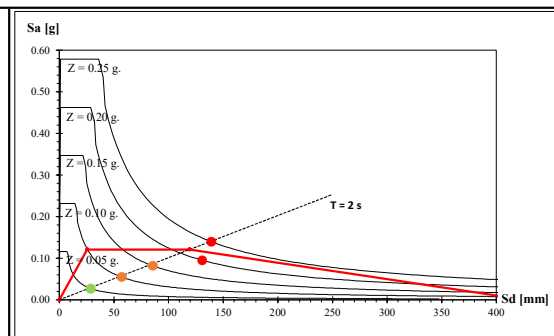

MODO DE FALLA G

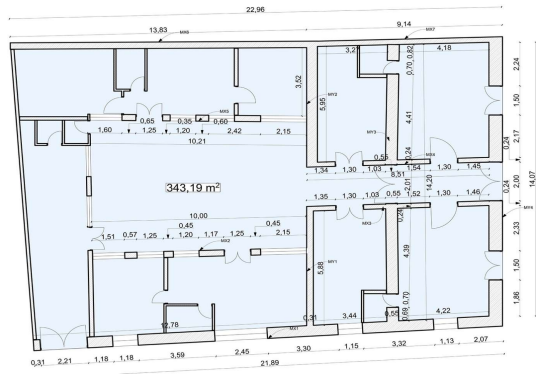

PLANTA

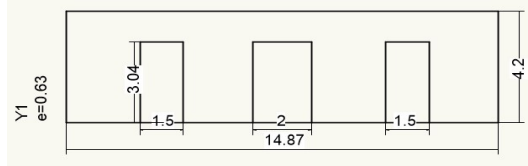

FACHADA



FOTOGRAFÍA

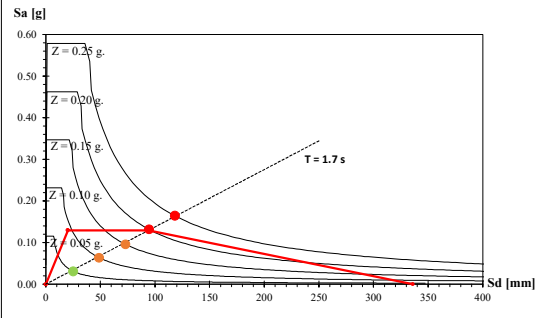

MODO DE FALLA A

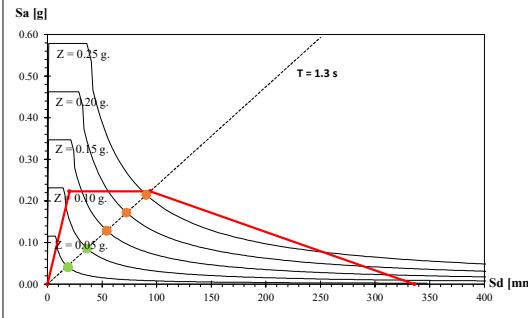

MODO DE FALLA B1

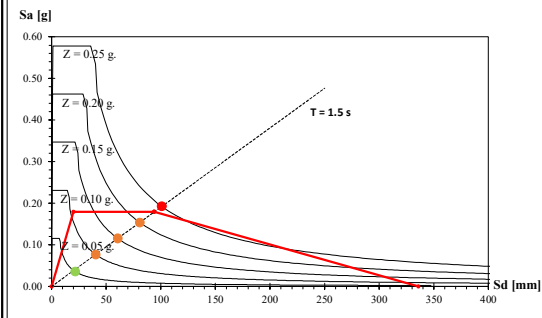

MODO DE FALLA B2

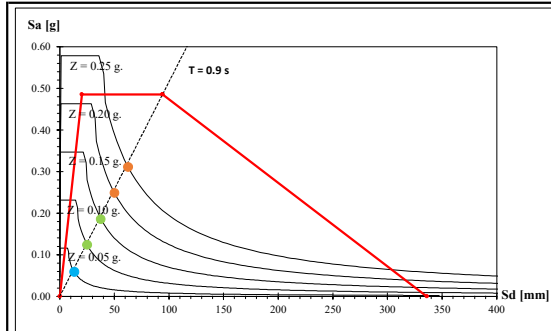

MODO DE FALLA D

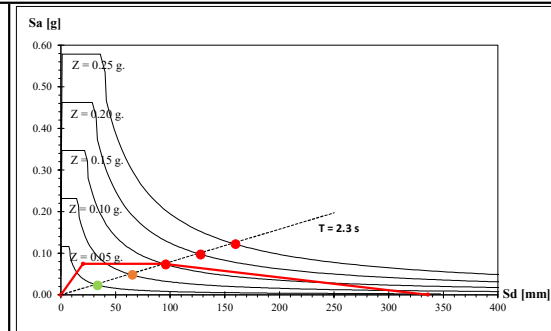

MODO DE FALLA G

CODIGO DE VIVIENDA

U41

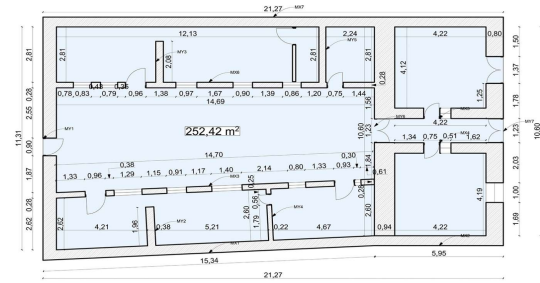

PLANTA

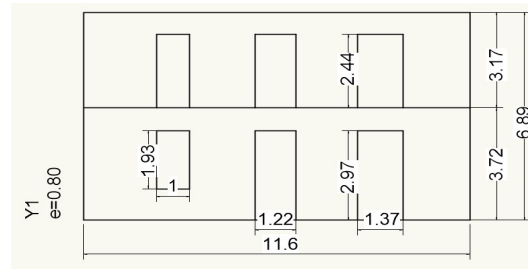

FACHADA



FOTOGRAFÍA

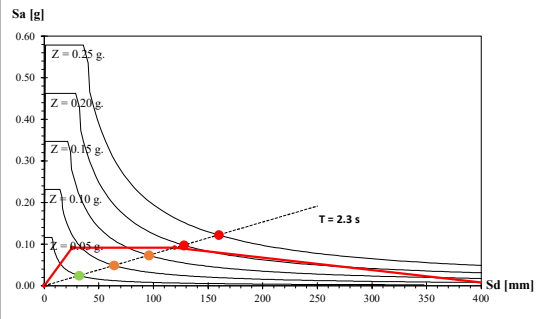

MODO DE FALLA A

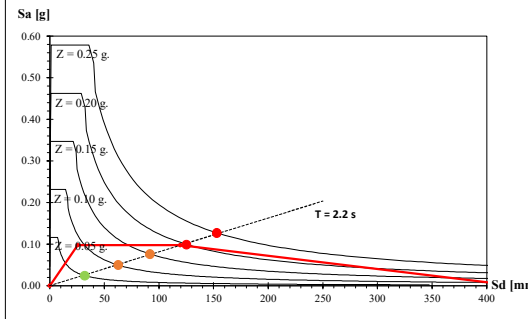

MODO DE FALLA B1

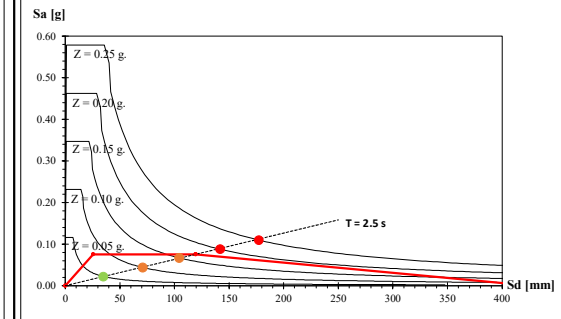

MODO DE FALLA B2

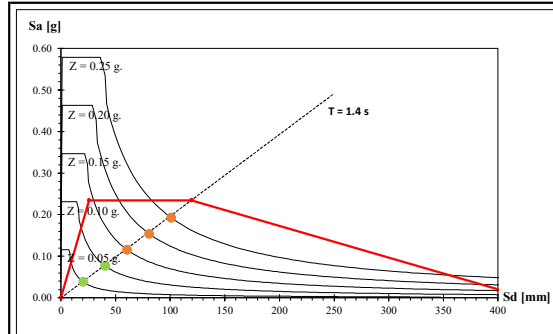

MODO DE FALLA D

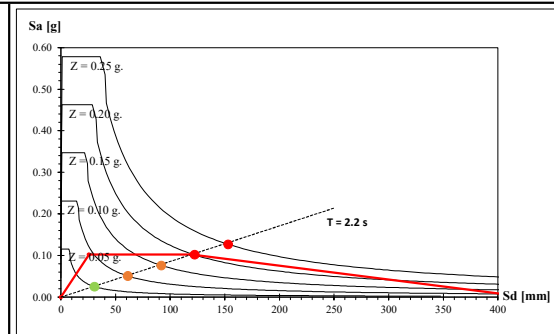

MODO DE FALLA G

CODIGO DE VIVIENDA

V42

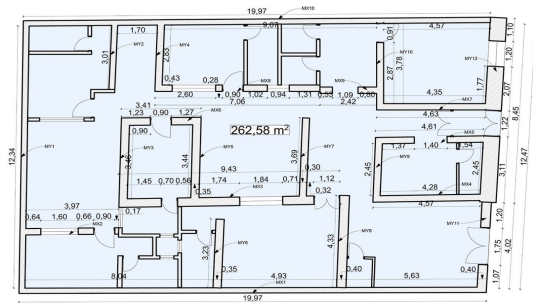

PLANTA

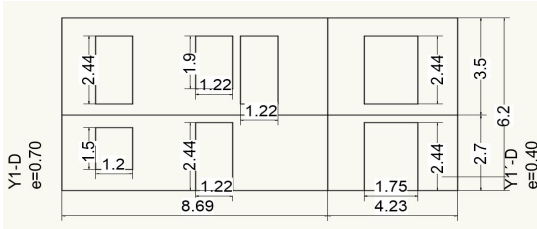

FACHADA



FOTOGRAFÍA

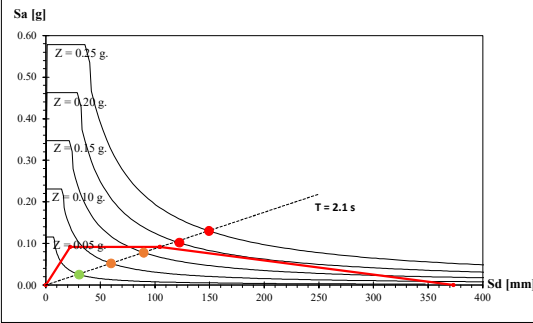

MODO DE FALLA A

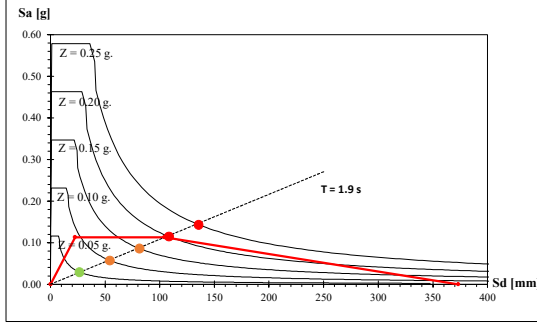

MODO DE FALLA B1

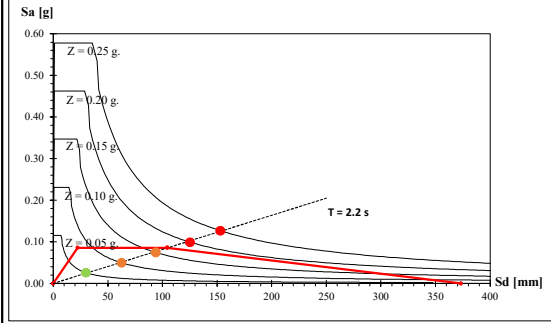

MODO DE FALLA B2

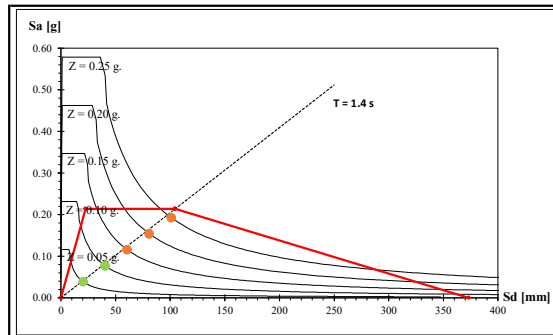

MODO DE FALLA D

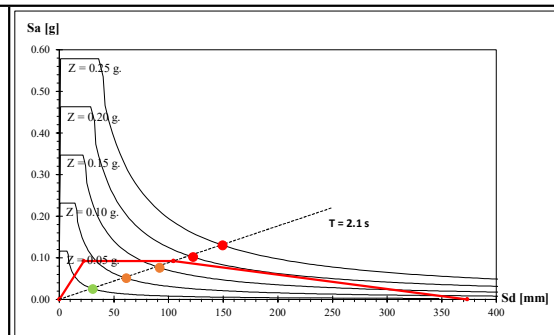

MODO DE FALLA G

CODIGO DE VIVIENDA

W43

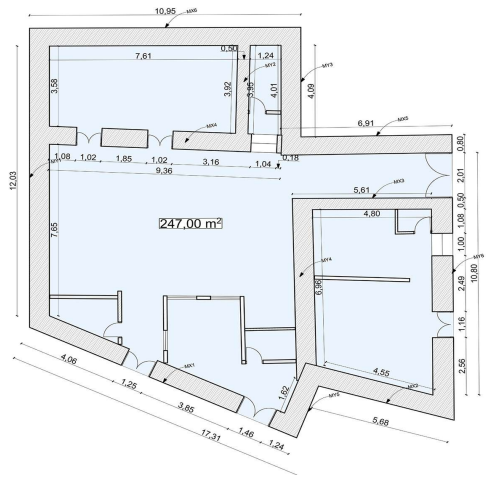

PLANTA

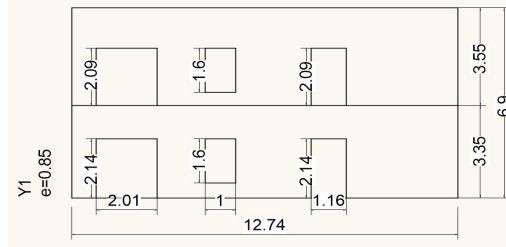

FACHADA



FOTOGRAFÍA

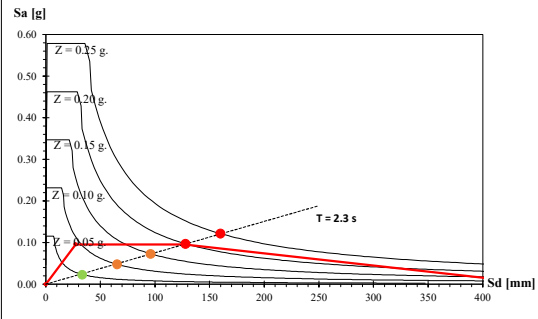

MODO DE FALLA A

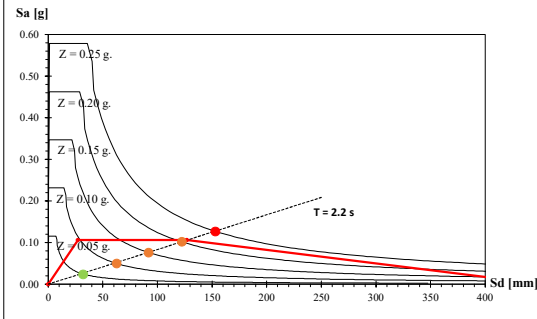

MODO DE FALLA B1

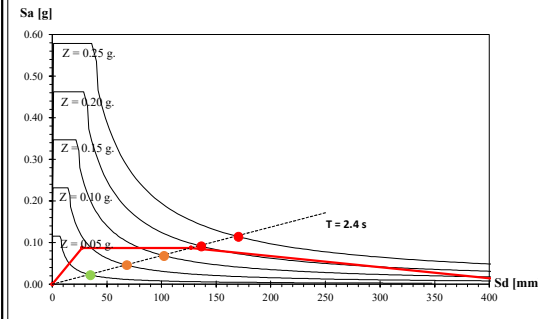

MODO DE FALLA B2

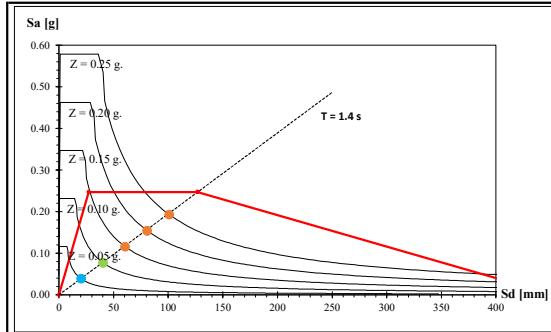

MODO DE FALLA D

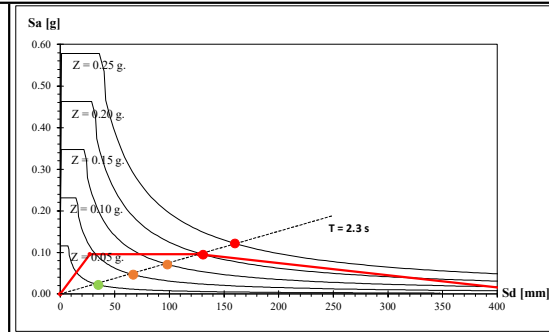

MODO DE FALLA G

CODIGO DE VIVIENDA

X44

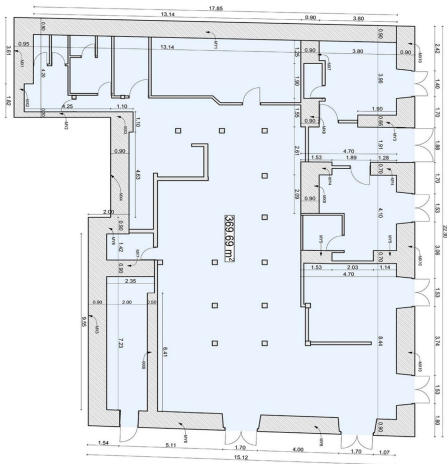

PLANTA

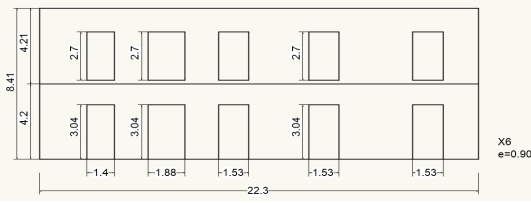

FACHADA



FOTOGRAFÍA

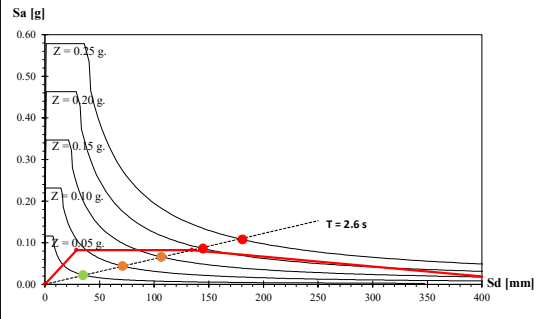

MODO DE FALLA A

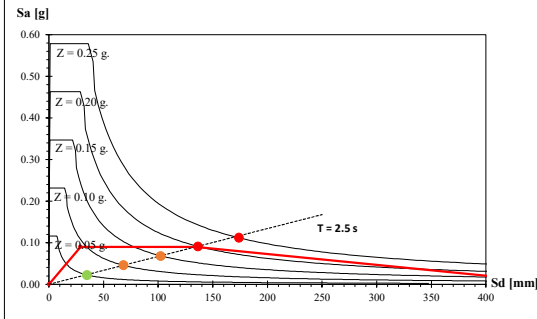

MODO DE FALLA B1

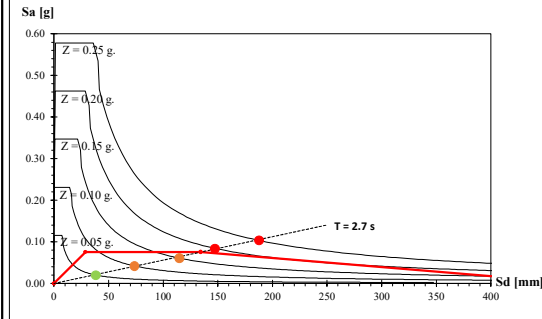

MODO DE FALLA B2

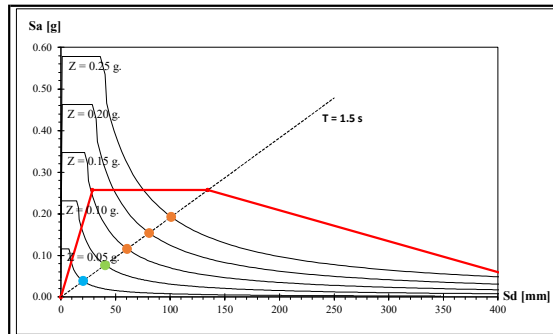

MODO DE FALLA D

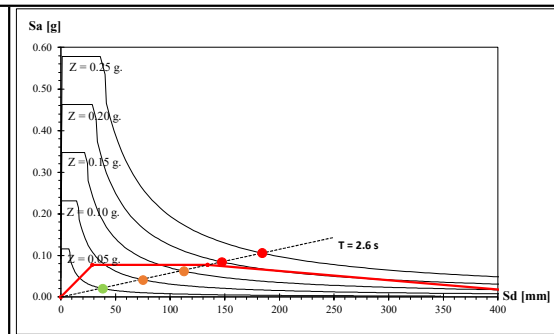

MODO DE FALLA G

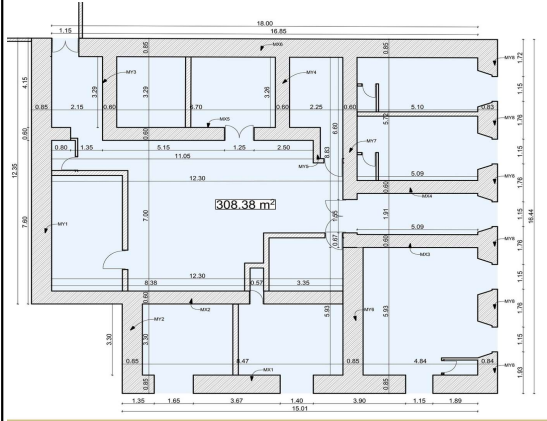

PLANTA

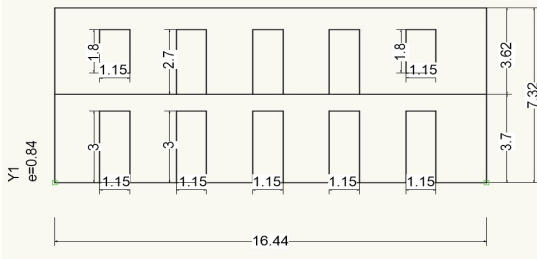

FACHADA



FOTOGRAFÍA

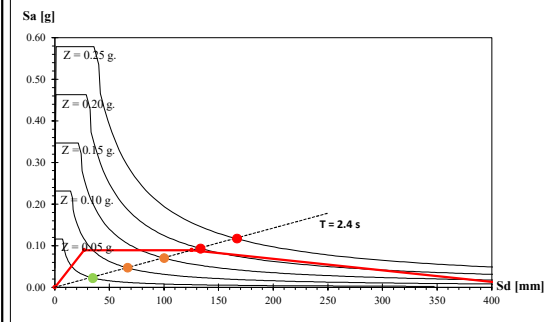

MODO DE FALLA A

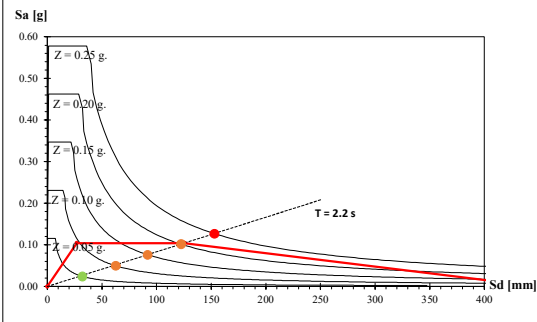

MODO DE FALLA B1

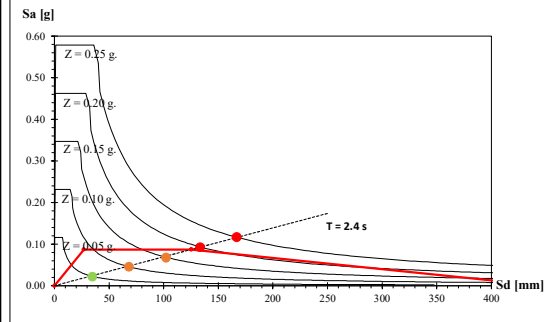

MODO DE FALLA B2

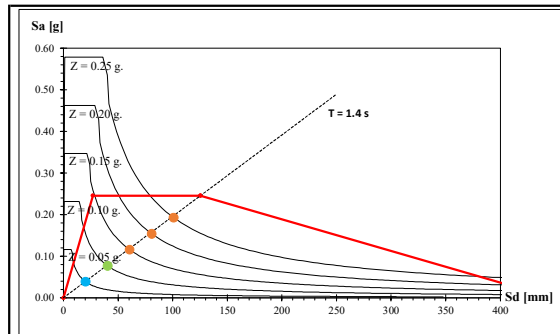

MODO DE FALLA D

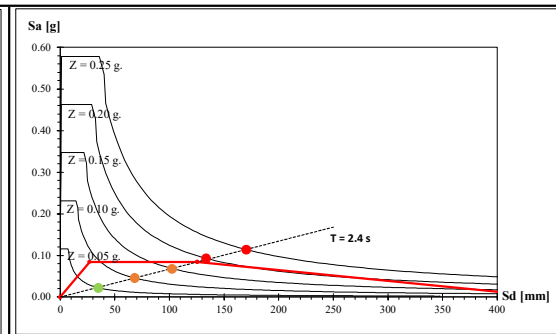

MODO DE FALLA G