



Original Article

Analysis of MBLOCA and LBLOCA success criteria in VVER-1000/V320 reactors: New proposals for PSA Level 1

Elena Redondo-Valero^a, César Queral^{a, *}, Kevin Fernandez-Cosials^a, Víctor Hugo Sanchez-Espinoza^b^a Universidad Politécnica de Madrid, Spain^b Karlsruhe Institute of Technology (KIT), Germany

ARTICLE INFO

Article history:

Received 31 May 2022

Received in revised form

6 September 2022

Accepted 7 October 2022

Available online 14 October 2022

Keywords:

VVER-1000/V320

TRACE

LOCA

PSA

ABSTRACT

The specific configuration of the safety systems in VVER-1000/V320 reactors allows a comprehensive study of the Loss of Coolant Accident (LOCA). In the present paper, a verification of the success criteria of the event trees headers for the medium and large break LOCA sequences is conducted. A detailed TRACEV5P5 thermal-hydraulic model of the reactor has been developed, including all safety systems. When analyzing the results of all sequences, some conservatism is observed in certain specific configurations as the success criterion of some headers is not consistent with the classic PSA level 1. Therefore, new proposals for the LOCA event trees are performed based on a reconfiguration of LOCA break ranges and the use of the expanded event trees approach.

© 2023 Korean Nuclear Society, Published by Elsevier Korea LLC. This is an open access article under the CC BY-NC-ND license (<http://creativecommons.org/licenses/by-nc-nd/4.0/>).

1. Introduction

Probabilistic Safety Assessment (PSA) and Deterministic Safety Analysis (DSA) are the methodologies for the overall safety evaluation of Nuclear Power Plants (NPP). PSA is based on both fault and event tree techniques that require reliability data of components/human actions to predict the probability of occurrence of accidental sequences.

There is an increased interest on the study of the plant behavior of VVER-1000/V320 reactors, which are one of the most common Russian-designed Pressurized Water-cooled Reactors (PWR) worldwide. Currently 25 units are being operated in Russia, Ukraine, Bulgaria and Czech Republic. In addition, the Gen III and Gen III + VVER reactors use its design as a basis. This design is a 4-loop reactor with a thermal power of 3000 MW_{th} and an electric output of 1000 MW. They share some similarities and differences regarding their safety injection systems with other PWRs as can be seen in Table 1 and [1], [2], [3], [4], [5], [6], [7], [8].

In the frame of PSA, Event Trees (ET) are used to identify the different outcomes of an Initiating Event (IE) depending on the

availability of safety systems or operator actions, and in this process evaluate the end state according to an acceptance criterion. The usual acceptance criterion is accomplished if the Peak Cladding Temperature (PCT) remains below 1477 K during the full transient. This temperature is the one used by many countries but in other countries with Light Water Reactors (LWR) the acceptance criterion is PCT below 1473 K, nevertheless this difference has a small impact on PSA results. The compliance or not with the criterion is assessed with system Thermal-Hydraulic (TH) codes. Then, the performance of those safety systems or crew human actions is compared against the end state defining the Success Criteria (SC) of the system, i.e., the minimum performance required to comply with the acceptance criteria of the sequence. This method plays a central role in the PSA of NPPs [9].

The principal steps in ET development consists of determining boundaries of the analysis, identifying Critical Safety Functions (CSF) available to mitigate each IE, determine systems or operators actions available to perform each CSF and determine the SC for each system.

Currently, there are new methods associated with ET which are still under development, such as the Expanded ET (EET) [10], [11] [12] [13], with its potential use for uncertainty analysis [10], or conditional ET [11].

In addition, the computational codes used to simulate the different transients of an ET are upgraded and improved over the

* Corresponding author.

E-mail addresses: elena.redondo.valero@upm.es (E. Redondo-Valero), cesar.queral@upm.es (C. Queral), kevin.fcosials@upm.es (K. Fernandez-Cosials).

Acronyms			
ATWS	Anticipated Transient without SCRAM	IE	Initiating Event
CL	Cold Leg	LBLOCA	Large Break Loss-of-Coolant Accident
CD	Core Damage	LWR	Light Water Reactors
CSF	Critical Safety Function	LPIS	Low Pressure Injection System
ECCS	Emergency Core Cooling System	MBLOCA	Medium Break Loss-of-Coolant Accident
EFW	Emergency Feed Water	NPP	Nuclear Power Plant
ET	Event Tree	PCT	Peak Cladding Temperature
EET	Expanded Event Tree	PWR	Pressurized Water Reactor
HPIS	High Pressure Injection System	RCS	Reactor Coolant System
HL	Hot Leg	RPV	Reactor Pressure Vessel
HA-DC	Hydro-Accumulator connected to the vessel Downcomer	SBLOCA	Small Break Loss-of-Coolant Accident
HA-UP	Hydro-Accumulator connected to the vessel Upper Plenum	SG	Steam Generator
		SGTR	Steam Generator Tube Rupture
		SC	Success Criterion
		SS	Steady State
		TH	Thermal-hydraulic

Table 1
PWR designs ECCS comparison.

	Westinghouse (3-loop)	Siemens (Konvoi)	Framatome (P4)	VVER-1000 V-320	VVER-1200 V392m	EPR	APR1400 Hualong	
Thermal Power	3000	3600	3800	3000	3600	5000	4000	3600
HPIS								
Number of trains	3	4	2	3	2	4	4	2 or 3
Shutoff head (MPa)	18	11	12.0–10.2	10.6	8.6	9.8	11–14.5	~9
Capacity per pump (kg/s)	50	62	68–136	78	83	40	50	~30
Accumulators								
Number of accumulators	3	8	4	4	4 (HA-1) 8 (HA-2)	4	4	2 or 3
Total capacity (m ³)	41 x 3 (36 + 5)	272	188	60 *4 (50 +10)	60 x 4 (HA-1) 120 x 8 (HA-2)	600 (400 + 200)	68 x 4	50 (35 –38)
Discharge pressure (MPa)	4.4	2.5	4.4	6	5.9 (HA-1) 1.5 (HA-2)	5.5	4	5.5
LPIS								
Number of trains	3	4	2	3	2	4	-	2 or 3
Shutoff head (MPa)	~ 1.5	0.9	2.3–2.0	2.5	~ 2.5	2.35	-	N/A
Capacity per pump (kg/s)	406.8	306	120–280	207.2	250	138.8	-	~130

years. This makes the verification of ET outcomes with these upgraded codes necessary, as previously unseen phenomenology or combination of phenomenology could be now simulated modifying the outcome of previous ET [14].

One of the most studied ET of all NPPs is the Loss of Coolant Accident (LOCA), due to its rapid and long-lasting impact on the integrity of the reactor core. The investigations of LOCA simulations in VVER type reactors is relatively extensive [15], [16], [17], [18] [19], [20], [21] [22], [23], [24]. However, there are no analyses in the open literature related to the LOCA ETs of this type of NPPs.

In the present paper, the MBLOCA and LBLOCA ETs are assessed for all break sizes, re-evaluating the SC of each safety system involved in the accident, and developing a new SC proposal for sequences where the old criterion can be updated. This work is performed using TRACEV5P5 code.

The current paper is structured as follows: Section 2 discusses the standard ET used in this paper of the accidental sequences of MBLOCA and LBLOCA. Then, the TH model is described in Section 3. In Section 4, a review of the SC proposed in the reference ET of Section 2 is made, and in Section 5, the possibility of relaxing them is analysed. With the new SC obtained before, two new approaches to the LOCA ETs are proposed, one using classic ETs and the other using EETs, in Section 6. Finally, Section 7 presents the conclusions obtained from these analyses.

2. Standard MBLOCA and LBLOCA event trees in a VVER-1000/V320 reactor

VVER-1000/V320 reactors have some unique characteristics that differ from the widely built PWR-W. For example, the Hot Legs (HL) are connected to the Reactor Pressure Vessel (RPV) in the same angular position than the Cold Legs (CL), nevertheless the connections of the four loops are not symmetric in azimuthal direction, but loops 1 and 4 are separated with an angle of 55° each other. The Steam Generators (SG) are horizontal and the core consists of 163 hexagonal fuel assemblies (61 of which contain control rods), each comprises 312 fuel rods that are arranged in a triangular grid [25] and made of Zr1% Nb alloy.

The Emergency Core Cooling System (ECCS) includes passive Hydro-Accumulators (HA), a High Pressure Injection System (HPIS) and a Low Pressure Injection System (LPIS). There are four HA (4T × 33%) with a total volume of 60 m³ partially filled with borated water (50 m³) and pressurized with N₂ to 60 bar, two of them are connected to the vessel upper plenum (HA-UP) and the two other to the downcomer (HA-DC). The HPIS includes three trains (3T × 100%) connected to the CL1, CL3 and CL4. The LPIS consists of three trains (3T × 100%), two of them connected to the injection lines of one type of HA and the other one to the CL1 and HL1 [26]. A summary of the ECCS layout is included in Fig. 1. The Emergency Feed Water (EFW) is an open circuit consisting of three trains, each capable of 100% duty (3T × 100%); of those, one supplies water to SG1 and SG4, another to SG2 and SG3 and the third to all four SG.

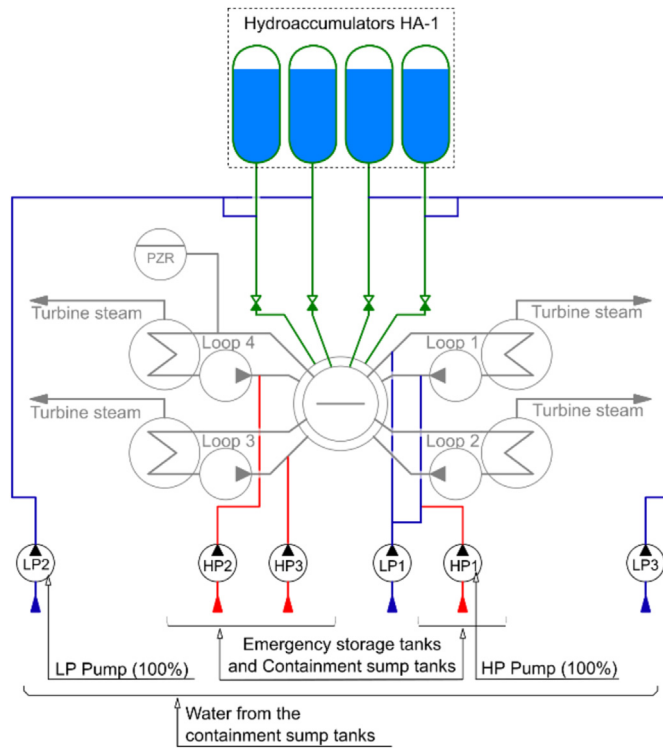

Fig. 1. ECCS configuration in VVER-1000/V320.

The safety systems of these reactors and its performance are utilized in the ET of the PSA. Some examples of ET for several IE in VVER-1000/V320 reactors can be found in [27]. In the present work, the ETs given for the Medium Break Loss of Coolant Accident (MBLOCA) and the Large Break Loss of Coolant Accident (LBLOCA) IEs are analysed. A brief description of them is presented in the following sections.

2.1. MBLOCA event tree

The ETs headers are related to CSF required for the mitigation of an accidental sequence, being arranged according to the expected order of operation of their respective safety systems. The MBLOCA IE has two CSFs: the reactivity control and the Reactor Coolant System (RCS) coolant supply. Related with the first is the “S” header which is associated with the SCRAM; and the second includes three headers: H (related to the HPIS), A (related to the HA) and L (related to the LPIS) [27]. A summary is presented below:

- S Header – SCRAM or reactor protection system actuation

The success of the S header consists of the insertion of the control rods in the core without getting stuck in an intermediate position when the trip set points of the reactor protection system are reached or when it is initiated by the operator. Its failure leads to an ATWS, not included in this analysis.

- H Header – High Pressure Injection System (HPIS)

This system performs the function of injecting borated water into the RCS when the pressure is high (set point at 10.78 MPa, shutoff pressure 12.00 MPa). H header SC is accomplished if 1 out of 3 HPIS trains inject successfully.

- A Header – Hydro-Accumulators (HA)

The HA re-flood the core with borated water when a LBLOCA or MBLOCA takes place. They can inject at an intermediate pressure (below 6 MPa). A header SC is accomplished if 1 out of 2 HA-UP and 1 out of 2 HA-DC inject successfully.

- L Header – Low Pressure Injection System (LPIS)

As the HPIS, the LPIS mission is to introduce borated water into the RCS but it can only inject at low pressure (set point at 2.55 MPa, shutoff pressure 2.5 MPa), to compensate for the coolant lost through the break. L header is considered successful if 1 out of 3 LPIS trains inject successfully.

In order to improve the readability of the paper, a specific wording is used to identify the sequences. A sequence is defined by concatenating the letter that identifies its headers written in upper or lower case so, if it is uppercase, it represents *success* while if it is in lower case it represents *failure* of the system. In addition, the number of operating trains out of the total is written before the letter if the system is available. For example, the wording h-2/4A-1/3L corresponds to a LOCA in which the HPIS has failed and two out of four HAs and one out of three LPIS trains have injected borated water into the RCS.

MBLOCA IE, which ranges between 2 and 8 inches, has only one sequence with a success end state, that is S-1/3H-2/4A-1/3L. In fact, if any header related to the RCS coolant supply CSF fail, the sequence leads to a Core Damage (CD) end state, see Fig. 2.

2.2. LBLOCA event tree

The LBLOCA IE has only one CSF, the RCS coolant supply, since reactivity does not play an essential role in this type of transients, therefore, the LBLOCA ET headers are: H, A and L. The SC for the headers A and L are as in the MBLOCA ET, nevertheless, the SC for the header H is more restrictive, going from 1 out of 3 to 2 out of 3 trains successfully injecting.

The LBLOCA ET has a range between 8 inches and the Double Ended Guillotine Break (DEGB). The DEGB area corresponds to 1.135 m² and an equivalent diameter of 47 inches as the diameter of the CL is 33.5 inches (85.09 cm). LBLOCA ET includes two sequences with a success end state: 2/3H-2/4A-1 and h-2/4A-1/3L, see Fig. 3, all other sequences reach a CD end state. Thus, for a success end state, it is mandatory that one HA injects into upper plenum and another one into downcomer, in addition to the injection of one LPIS or two HPIS trains.

3. VVER-1000/V320 thermal-hydraulic model

In order to study the ET, a TH model of the plant has been created. The VVER-1000/V320 model for the TRACEV5P5 code [28], has been built based on a previous VVER-1000/V320 RELAP5 model [29], and includes 255 TH components, 300 SIGNAL VARIABLES, 680 CONTROL BLOCKS and 46 TRIPS. The resulting integral plant model consists of following elements:

- Primary loops: CLs, Reactor Coolant Pumps (RCP) and HLs (Fig. 4).
- Pressurizer (PZR): connected to the HL 4 by the surge line. It contains spray lines, attached to the CL 1, three safety valves and four groups of heaters (Fig. 4).
- RPV: it has been modelled by a 3D VESSEL component which is divided into 29 axial nodes, 6 azimuthal sectors and 6 radial sectors (Fig. 4). The three internal rings correspond with the core, the fourth ring model the bypass whereas the core barrel is

MBLOCA (2 in. - 8 in.)	S	H	A	L	Nº	End States
	SCRAM	1/3 HPIS	1/2 HA-UP + 1/2 HA-DC	1/3 LPIS		

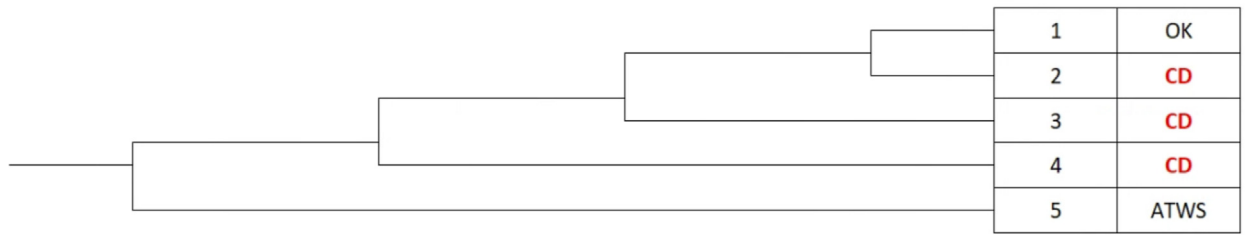

Fig. 2. Standard MBLOCA event tree of VVER-1000/V320 [27].

LBLOCA (8 in. - DEGB)	H	A	L	Nº	End States
	2/3 HPIS	1/2 HA-UP + 1/2 HA-DC	1/3 LPIS		

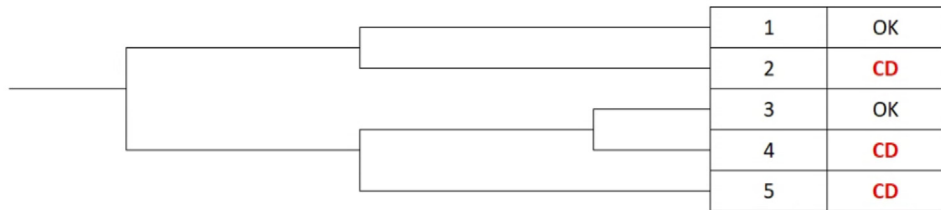

Fig. 3. Standard LBLOCA event tree of VVER1000/V320 [27].

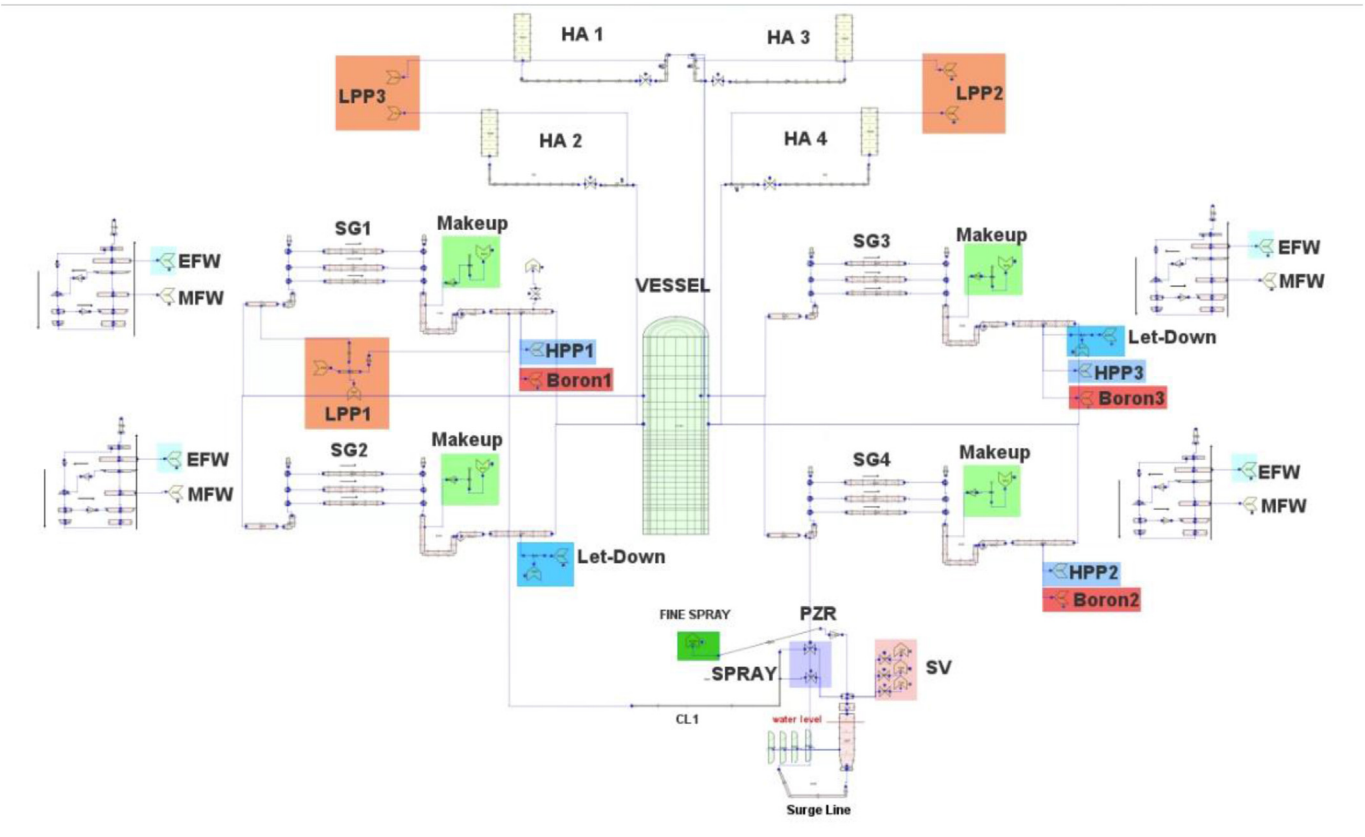

Fig. 4. Primary side of VVER-1000/V320 TRACE TH model.

model by the fifth ring and the downcomer by the sixth ring. The VESSEL also contains the lower and the upper grid plate as well as the upper head.

- Core: A total of 18 HEAT STRUCTURE components are used to model the 50856 fuel rods (163 hexagonal fuel assemblies, each with 312 fuel rods), one for each azimuthal and radial sector. Those in radius 1 have a surface multiplier of 1924, those in radius 2 have a surface multiplier of 2808 and those in radius 3 have a surface multiplier of 3744. Each HEAT STRUCTURE, has a height of 4 m and is divided into 12 axial levels, 10 of which correspond to the active part of the fuel rods. A cosine axial power distribution is assumed and a hot fuel rod peaking factor of 1.74 [30] has been included.
- Steam Generators (primary side): consists of tubes modelled by three horizontal PIPE and collectors modelled by three PIPE each (Fig. 4).
- Steam Generators (secondary side): contains three levels where heat transfer occurs, corresponding with the three U-shape tubes PIPEs of the primary side (Fig. 5). In the upper part is placed the liquid/steam separator.
- Steam lines: including one steam dump valve to the atmosphere (BRU-A), two safety valves (SV), one main isolation valve (BZOK) and a check valve (CHV) in each steam line (Fig. 5).
- Steam header: containing steam dump valves to the condenser (BRU-K), steam dump valves to the atmosphere (BRU-SN) and the turbine connection (Fig. 5).
- The model also includes the Emergency Boron Injection System (EBIS), the Control Volume and Chemical System (CVCS) (comprising the Make-up and the Let-down), the ECCS (consisting of the HA, the HPIS and the LPIS), the Main Feed Water (MFW) and the EFW.

The Steady State (SS) values of the TRACE TH model are compared with reference data from a VVER-1000/V320 NPP in Table 2. In order to demonstrate the proper performance of the TRACE TH model, Sections 3.1 and 3.2 show the evolution of a MBLOCA and a LBLOCA respectively.

Table 2
Steady state parameters of VVER-1000/V320.

Parameter	Reference NPP [31].	TRACEV5P5
Core power [MW]	3010	3010
Lower plenum pressure [MPa]	15.84	15.86
Core outlet pressure [MPa]	15.70	15.74
PZR level [m]	8.70	8.71
CLs temperature [K]	560.85	560.96
HLs temperature [K]	591.55	591.13
Average loop mass flowrate [kg/s]	4456.00	4457.21
SG outlet pressure [MPa]	6.27	6.27
MFW mass flowrate [kg/s]	409.00	408.09
MFW temperature [K]	493.00	493.00
SG level [m]	2.50	2.50

3.1. MBLOCA base sequence

A description of the selected MBLOCA base sequence S-1/3H-2/4A-1/3L, a 2 inches MBLOCA located in CL-1, is presented in Table 3. The transient starts at 300 s, with a break mass flowrate peak of 240 kg/s and inducing a fast depressurization of the RCS. This causes the triggering of the HPIS signal at 470 s and the opening of the HA check valves at the 760 s. ECCS coolant entering the RPV causes the depressurization rate to decrease, see Fig. 6, and therefore the LPIS pressure set point is not reached until 5000 s. Nevertheless, the LPIS signal does not trigger because the difference between the HLs temperature and the saturation temperature has to be less than 10 K. Consequently, the LPIS does not start injecting until 8036 s. At 10000 s, the mass flowrate through the break and the ECCS injection equals, allowing a nearly SS to be reached, Fig. 6 (right). The secondary side pressure follows the behaviour of that of the RCS, Fig. 6 (left). Finally, it can be concluded that, applying the SC of the PSA L1 from [27], the core is covered during all periods of the accidental sequence, Fig. 7 (right) and, therefore, no CD occurs, Fig. 7 (left).

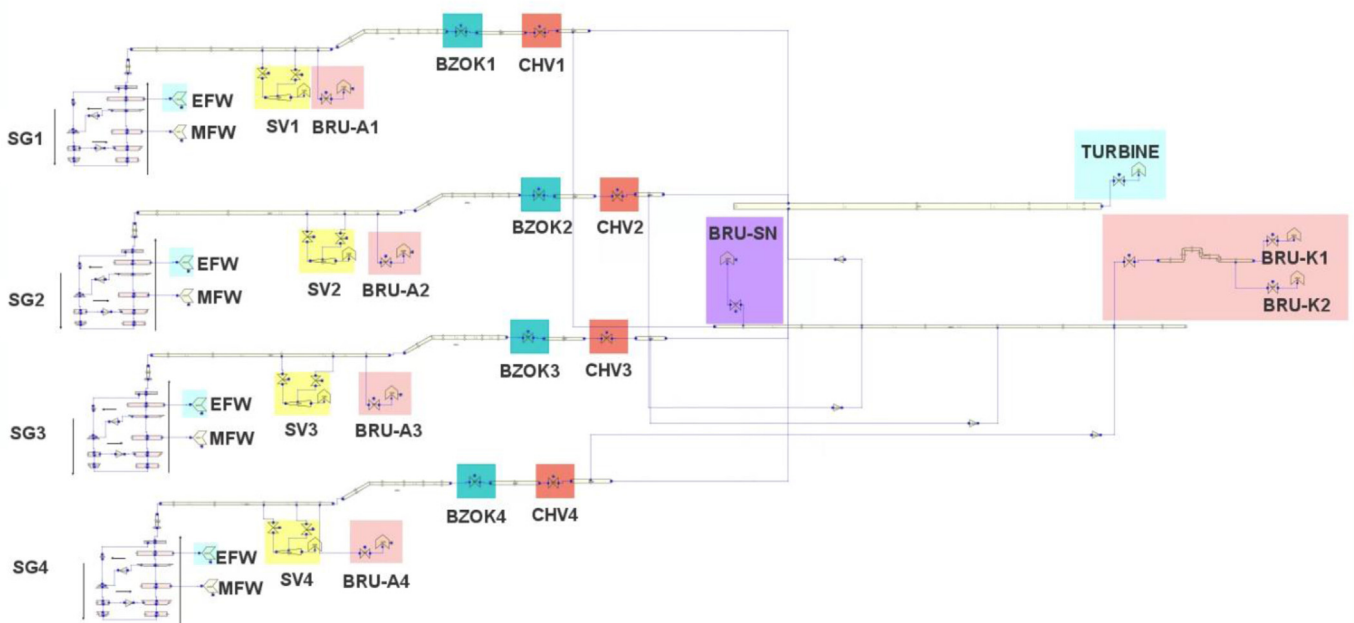

Fig. 5. Secondary side of VVER-1000/V320 TRACE TH model.

Table 3
MBLOCA (2 inches) base sequence S-1/3H-2/4A-1/3L.

Time [s]	Event
300	MBLOCA ($\varnothing = 2$ inches).
315	SCRAM signal (Power > 2250 MW and $P_{\text{core-outlet}} < 1.47\text{E}7$ Pa).
	TT and MFW pumps shutdown signals ($P_{\text{HL}} < 1.471\text{E}7$ Pa).
315.3	Start of the Control Rods insertion (signal + delay).
319.3	Control Rods fully inserted.
330	TT (signal + delay + turbine closing time).
355	MFW pumps shutdown and EFW pumps start-up (signal + delay).
470	Start of the HPIS injection (setpoint: $P_{\text{DC}} < 1.078\text{E}7$ Pa and $T_{\text{sat}} - T_{\text{HL}} < 10\text{K}$).
760	HA-1 and HA-4 injection ($P_{\text{DC/UP}} < 6.07\text{E}6$ Pa).
1405	RCPs coastdown begins and closing of the MSIVs ($P_{\text{SL}} < 4.69\text{E}6$ Pa).
1635	RCPs fully stopped
8036	Start of the LPIS injection (setpoint: $P_{\text{DC}} < 2.55\text{E}6$ Pa and $T_{\text{sat}} - T_{\text{HL}} < 10\text{K}$).
10000	End of the simulation.

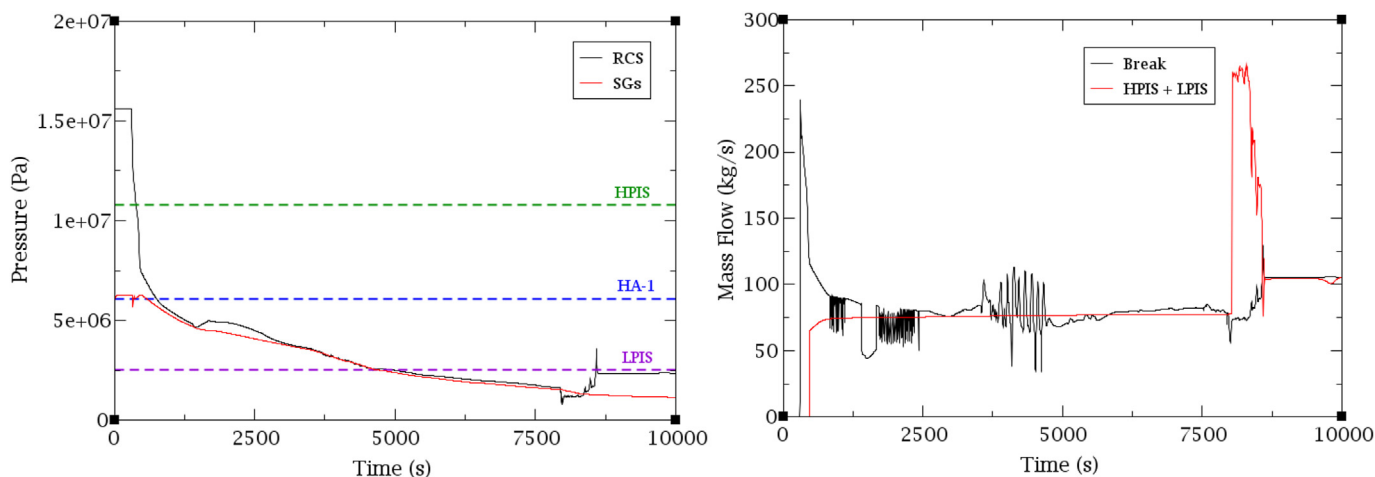

Fig. 6. RCS and SGs pressure (left) and RCS Inlet/Outlet mass flowrate (right); 2 inches MBLOCA reference sequence S-1/3H-2/4A-1/3L.

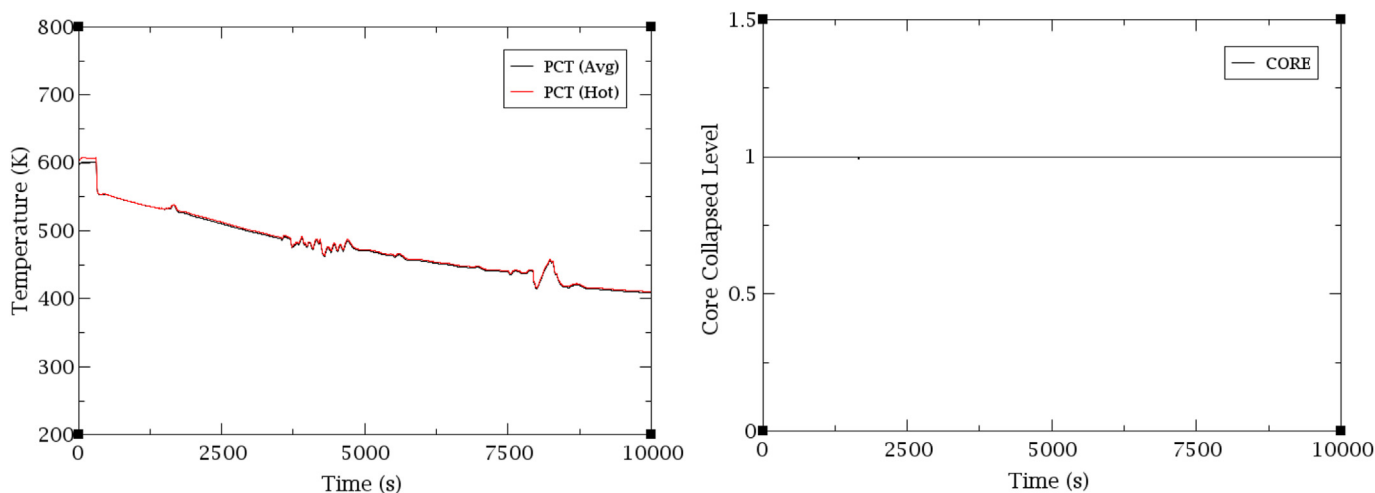

Fig. 7. PCT (left) and core collapsed liquid level (right); 2 inches MBLOCA reference sequence S-1/3H-2/4A-1/3L.

3.2. LBLOCA base sequence

A description of the selected LBLOCA reference sequence h-2/4A-1/3L, a DEGB LBLOCA located in the CL-1, is presented in Table 4. The break occurs at 300 s and during the first seconds of the transient the RCS pressure reaches atmospheric values, Fig. 8 (left) while the core gets uncovered, Fig. 9 (right). Despite the quick

actuation of two HAs and one LPIS train, core reflooding is not completed until 1620 s, Fig. 9 (left). At 2500 s, the LPIS mass flowrate equals the break leakage and the core collapsed level is stabilized allowing to reach a nearly SS. Then, it can be seen that CD has not occurred, since the PCT does not exceed 1477 K and the Local Maximum Oxidation did not surpass 17%, Fig. 8 (right).

Table 4
DEGB LBLOCA reference sequence h-2/4A-1/3L.

Time (s)	Event
300	DEGB-LBLOCA
302	SCRAM signal (Power > 2250 MW and $P_{\text{core outlet}} < 1.47\text{E}7$ Pa). TT and FW pumps shutdown signal ($P_{\text{HL}} < 1.471\text{E}7$ Pa). Core is uncovered.
302.3	Start of the control rods insertion (signal + delay).
306.3	Control Rods fully inserted.
310	RCPs coastdown begins ($P_{\text{SL}} < 4.69\text{E}6$ Pa and $\text{Level}_{\text{SG}} < 2\text{m}$). Closing of the MSIV ($P_{\text{SL}} < 4.69\text{E}6$ Pa). Start of HA-1 and HA-4 injection ($P_{\text{DC/UP}} < 6.07\text{E}6$ Pa).
315	TT (signal + delay + turbine closing time). Start of the LPIS injection ($P_{\text{DC}} < 2.55\text{E}6$ Pa and $T_{\text{sat}} - T_{\text{HL}} < 10\text{K}$).
340	MFV pumps shutdown and EFW pumps start-up (signal + delay).
545	Zero angular velocity of the RCPs
760	Maximum PCT (1253 K).
1390	Core collapsed liquid level starts to increase.
1620	Core re-flooding ends.
2500	Core collapsed level stabilized. End of the simulation.

Table 5
Maximum PCT for the MBLOCA reference success sequence.

Break size	PCT
	S-1/3H-2/4A-1/3L
2 in.	607 K
3 in.	607 K
4 in.	607 K
6 in.	607 K
8 in.	661 K

results obtained in the simulations for the MBLOCA sequences with a success end state, S-1/3H-2/4A-1/3L, show a wide safety margin as the PCT values are largely under 1477 K, see Table 5. The 8 inches MBLOCA is the only break size where the maximum PCT exceeds the operational value by 56 K. The maximum PCT reached in the LBLOCA success end state sequences; 2/3H-2/4A-1 and h-2/4A-1/3L, also shows a large safety margin, although it decreases as the LBLOCA break size increases, see Table 6. Therefore, it can be confirmed that the SC in [27] for the MBLOCA and LBLOCA IEs are valid. However, they can be conservative and then, a refined SC are sought in the following section.

4. MB/LBLOCA success criteria verification

A verification of the sequences with a success end state has been performed for all break sizes of both MBLOCA and LBLOCA ETs. The

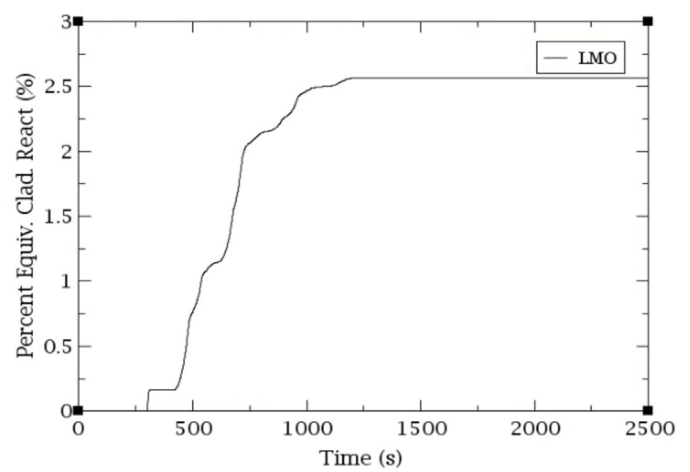
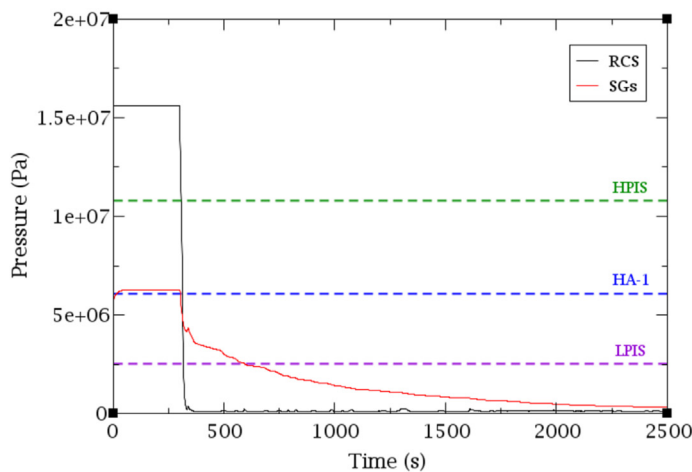

Fig. 8. RCS pressure (left) and Equivalent Cladding Reacted (right); DEGB LBLOCA reference sequence h-2/4A-1/3L.

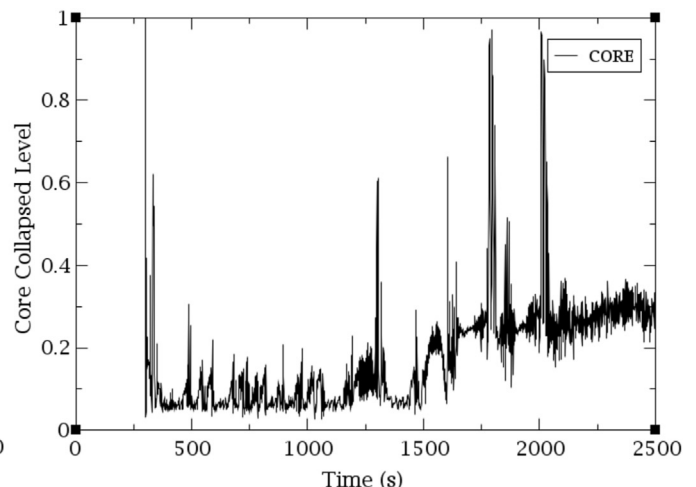
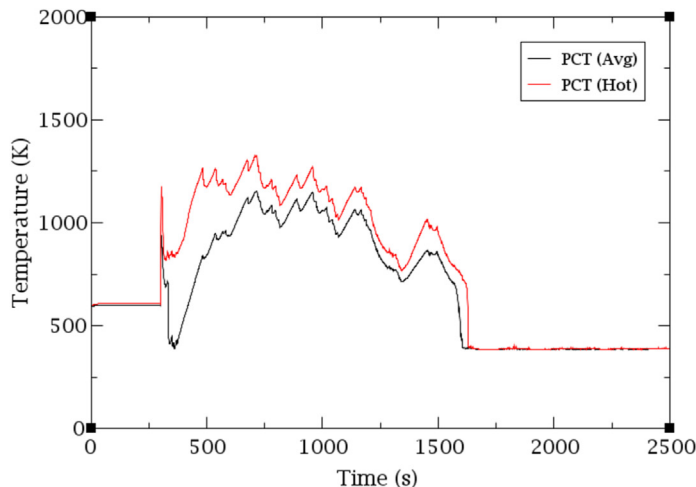

Fig. 9. PCT (left) and core collapsed liquid level (right); LBLOCA reference sequence h-2/4A-1/3L.

5. MB/LBLOCA refined success criteria.

In order to carry out a more in-depth study, it has been evaluated whether there are other sequences with different SC from those previously analyzed. Hereby, new simulations have been performed considering all configurations for the HPIS, HA and LPIS systems, applying a similar approach to [32], as well as the entire MBLOCA and LBLOCA break size range. For that purpose, a preliminary generic MB/LBLOCA ET has been considered, see Fig. 10, on which the following assumptions have been made:

- In the MBLOCA sequences, the SC of the ECCS-related headers have been examined based on the assumption that the reactor SCRAM always occurs, i.e., ATWS sequences have not been analyzed. On other hand, in the LBLOCA sequences the performance of SCRAM has not been considered, since, as mentioned above, SCRAM does not cover any CSF for this IE.
- All sequences in which both the LPIS and HPIS are not available, i.e. S6 and S8 in Fig. 10, have not been analyzed since it is already known that they cannot reach a success end state due to the fact that the CSF of the RCS coolant supply will not be fulfilled in the long term. Therefore, the sequences considered for both IEs have been: S1, S2, S3, S4, S5 and S7, with the exception that the S-header is only considered in the MBLOCA sequences.

5.1. Review of the MBLOCA success criteria

More than 50 MBLOCA simulations have been performed considering different configurations of HPIS, HA and LPIS systems, as well as various break sizes. The minimum configuration of the ECCS required to avoid the CD, obtained for each of the five break sizes simulated, along with the PCT values are shown in Table 7. As an example, Fig. 11 presents the evolution of the RCS pressure (left) and the PCT (right) for the full MBLOCA range of the sequence S-1/3H-a-l. Fig. 12 shows the different cases for a break of 2 inches.

It has been found that 1 out of 3 HPIS trains are enough to reach a success end state for the whole MBLOCA break size range. In addition, 1 out of 3 LPIS trains are also adequate for 3 to 8 inches MBLOCA IE to avoid CD. Nevertheless, for the 2 inches MBLOCA it has been proven that 3 out of 3 LPIS trains plus 4 out of 4 HAs are required if no HPIS train is available, as shown in Fig. 12.

Thus, it can be considered that the MBLOCA ET in [27] contains conservatism since it assumes that to have a sequence with a success end state all three ECCS (1 out of 3 HPIS trains plus 1 out of 3 LPIS trains plus one HA of each type (HA-UP + HA-DC)) are needed, but according to the simulations performed, over the whole MBLOCA range (from 2 to 8 inches), the single actuation of HPIS (1 out of 3 trains) is enough to prevent reaching a PCT value of 1477 K.

Table 6
Maximum PCT for the LBLOCA reference success sequences.

Break size	PCT	
	2/3H-2/4A-l	h-2/4A -1/3L
8 in.	638 K	607 K
12 in.	607 K	607 K
20 in.	849 K	1005 K
25 in.	1102 K	1155 K
30 in.	1250 K	1302 K
DEGB	1387 K	1305 K

5.2. Review of the LBLOCA success criteria

For a similar approach to MBLOCA analysis, about 50 LBLOCA simulations have been performed, considering different HPIS, HA and LPIS systems configurations, as well as multiple break sizes. As an example, Fig. 13 presents the evolution of the RCS pressure (left) and the PCT (right) for all the LBLOCAs analyzed with the only availability of the L header (sequence h-a-1/3L for LBLOCAs from 8 to 25 inches and sequence h-a-2/3L for LBLOCAs from 30 inches to DEGB).

Table 8 shows all the SC obtained for the six LBLOCA break sizes evaluated together with their PCT values. It can be seen how the ECCSs SC gets stringent as the break size increases; from 3 to 12 inches it is enough with a single LPIS or HPIS train to avoid the CD, but as break size get larger, the availability of more safety systems is required.

Furthermore, for 20 inches LBLOCAs onwards, more than one SC appears for some ECCSs. This is because, for larger LBLOCAs, LPIS and HPIS require the availability of more trains if they operate alone than if they perform their safety function in combination with another safety injection system. On other hand, it has been found that from 30 inches LBLOCA onwards, the sole availability of all three HPIS trains is not enough to avoid the CD. However, the sole availability of two LPIS trains is enough to have a success sequence in the DEGB LOCA. Fig. 14 shows the RCS pressure (left) and the PCT (right) for the DEGB sequences included in the Table 8.

It can be highlighted how in none of the LBLOCAs the injection of the HA is a necessary requirement to prevent the PCT from exceeding 1477 K, since the availability of the LPIS and the HPIS, with different configurations, is enough to reach the success end state.

Moreover, the success sequence 1/3H-1/3A-l for the 30 inches LBLOCA follows a non-monotonic trend, as the HA SC is relaxed to a single train relative to the 25 inches LBLOCA where the injection of 2 HAs is required if only one HPIS train and no LPIS trains inject successfully. This is because a larger break has a double effect. In the one hand, the mass flowrate through the break is greater and therefore the RCS inventory is lost in a shorter time, and therefore the core uncover is reached earlier. On the other hand, the larger the break, the faster the RCS depressurizes and the injection systems can actuate sooner. For all these reasons, the SC are not always monotonic with respect to the break diameter. This type of behaviour has also been found in other designs such as the Westinghouse PWR [32].

6. Event tree and success criteria proposals

The SC of the MBLOCA and LBLOCA ETs have been reviewed in Sections 5, the results obtained in both ETs are summarized in Table 9. The results show that the SC for MBLOCA from 3 to 8 inches and those for LBLOCA from 8 to 12 inches are identical, since the sole availability of one HPIS train or that of the LPIS is enough to prevent the CD end state. This indicates that it is possible to modify the boundaries between both IEs, by increasing the MBLOCA break size range from [2–8] inches to [2–12] inches and thereby reducing the LBLOCA break size range from [8 inches – DEGB] to [12 inches – DEGB].

The classic PSA uses a binary state for each header: failure or success, which presents a challenge since, as seen in Section 5.2 and Table 9, for some sequences there is more than one SC. Some different approaches to handle this drawback are available, two of them are proposed in the following Sections 6.1 and 6.2.

In the first approach, a careful selection of the SC has been carried out with the aims of establishing new classic ETs. In a

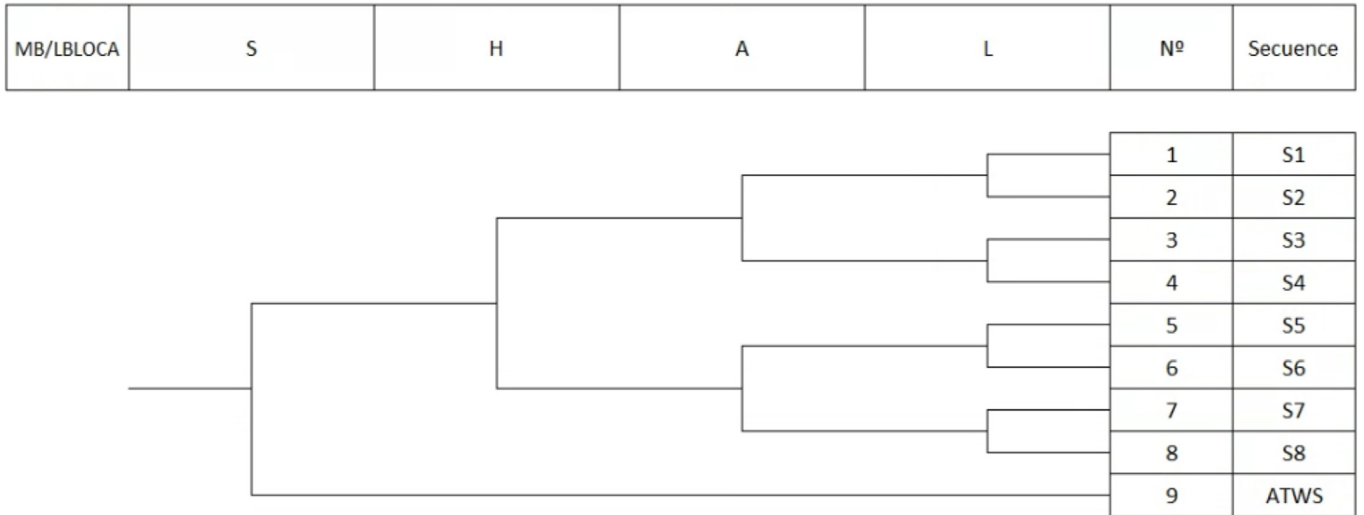

Fig. 10. MB/LBLOCA generic event tree.

Table 7
Success criteria and maximum PCT (MBLOCA Sequences).

Sequence	BREAK SIZE				
	2 in.	3 in.	4 in.	6 in.	8 in.
S1: H-A-L					
S2: H-A-L	1/3 H (607 K)	1/3 H (607 K)	1/3 H (607 K)	1/3 H (607 K)	1/3 H (607 K)
S3: H-a-L					
S4: H-a-l					
S5: h-A-L	4/4 A + 3/3 L (1374 K)	1/3 L (1169 K)	1/3 L (923 K)	1/3 L (656 K)	1/3 L (655 K)
S7: h-a-L	CD (>1477 K)				

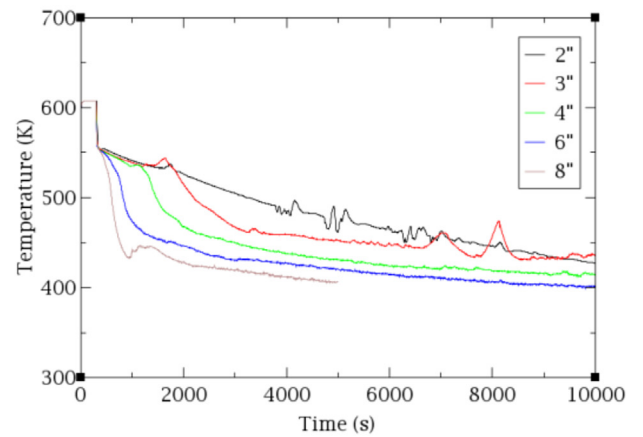
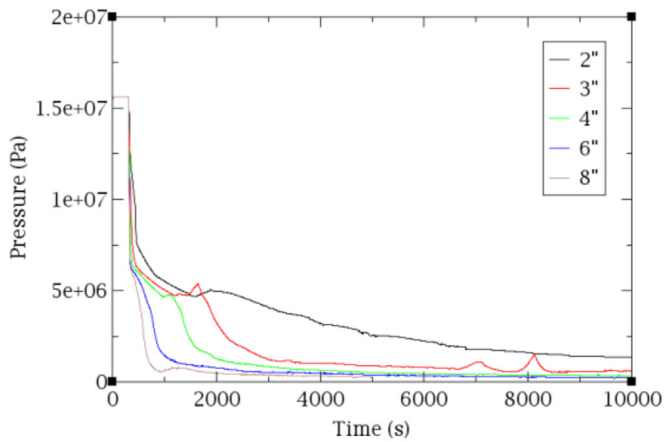

Fig. 11. RCS Pressure (left) and PCT (right); MBLOCA S-1/3H-a-l sequence.

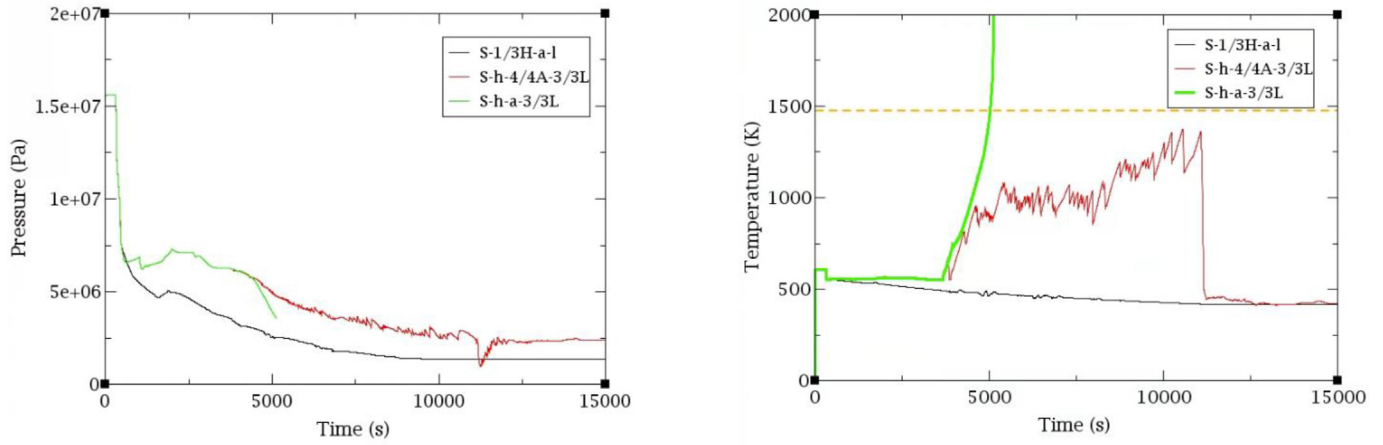

Fig. 12. RCS Pressure (left) and PCT (right); MBLOCA 2 inches sequences.

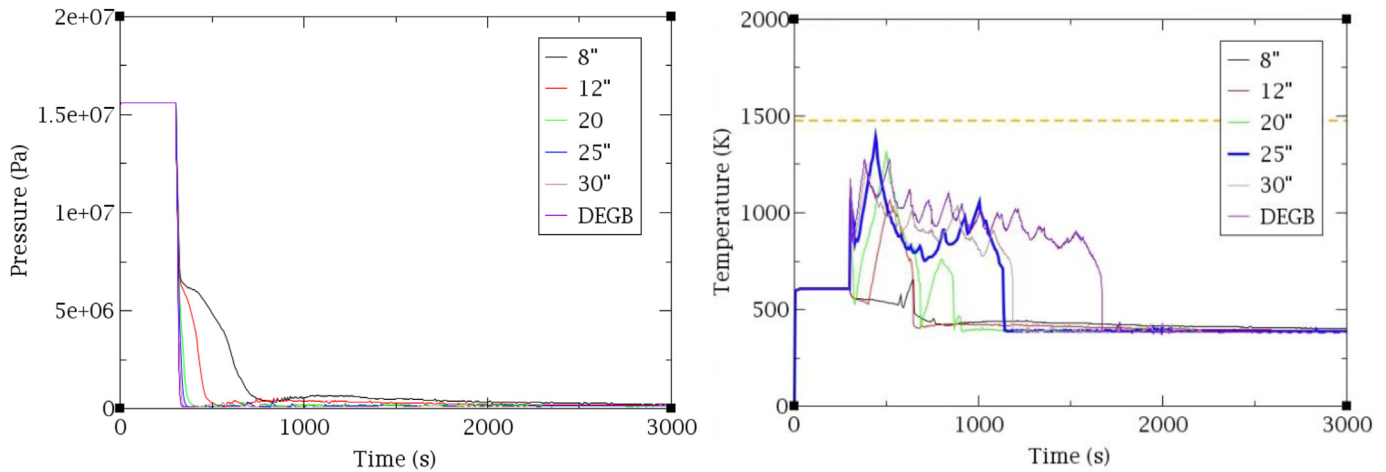

Fig. 13. RCS Pressure (left) and PCT (right); LBLOCA h-a-1/3L [8 inches–25 inches] and h-a-2/3L [30 inches-DEGB] sequence.

Table 8
Success criteria and maximum PCT (LBLOCA Sequences)..

Sequence	BREAK SIZE					
	8 in.	12 in.	20 in.	25 in.	30 in.	DEGB
S1: H-A-L						1/3 H+ 1/4 A + 1/3 L (1305 K)
S2: H-A-I	1/3 H (607 K)	1/3 H (723 K)	1/3 H + 1/4 A (849 K)	2/3 H + 1/4 A (1184 K) 1/3H + 2/4 A (1228 K)	1/3H + 1/4 A (1119 K)	2/3 H + 1/4 A (1428 K)
S3: H-a-L			2/3 H (1266 K)	3/3 H (1309 K)	1/3 H + 1/3 L (1338 K)	2/3 H + 1/3 L (1349 K)
S4: H-a-I					CD (>1477 K)	CD (>1477 K)
S5: h-A-L	1/3 L (655 K)	1/3 L (1067 K)	1/3 L (1314 K)	1/3 L (1392 K)	1/4 A + 1/3 L (1169 K)	2/4 A + 1/3 L (1305 K)
S7: h-a-L					2/3 L (1251 K)	2/3 L (1275 K)

second approach, it is proposed to use EETs that allow to consider all available configurations of the safety injection systems and not only their minimum requirement to meet the CSF, i.e. they provide the possibility to consider more than one SC for each ECCS.

6.1. Event trees for the classic PSA approach.

In the current Section, considering the SC obtained in previous Sections 5.1 and 5.2, new classic ETs for MBLOCA and LBLOCA IEs are proposed. First, a grouping of the break size ranges with the

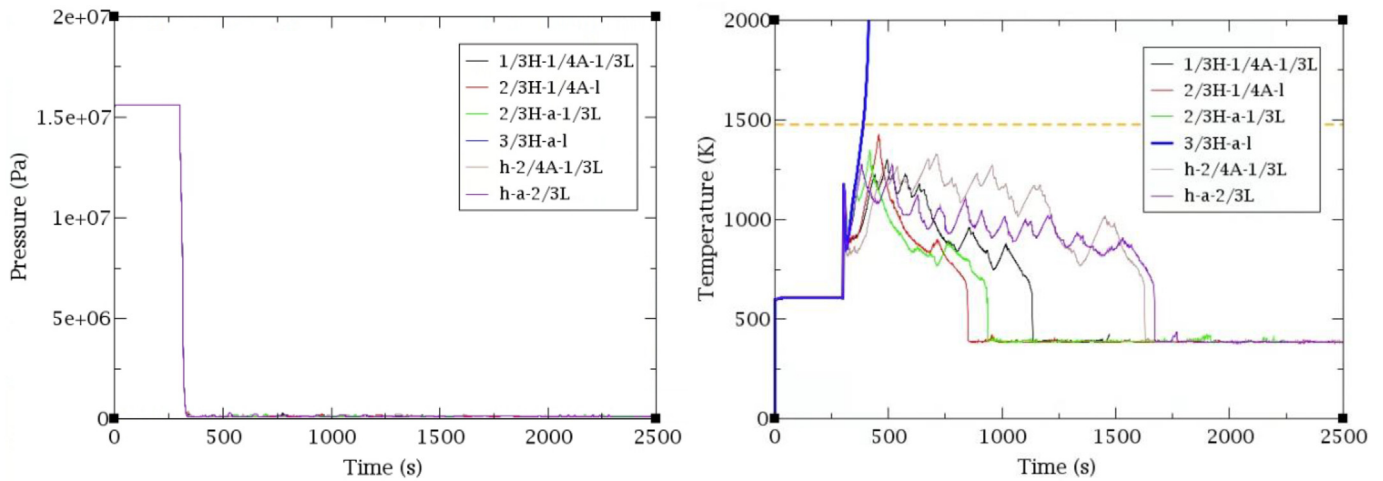

Fig. 14. RCS Pressure (left) and PCT (right); LBLOCA DEGB sequences.

Table 9
New MBLOCA and LBLOCA success criteria.

Sequence	BREAK SIZE					
	2 in.	3 in.-12 in.	20 in.	25 in.	30 in.	DEGB
S1: H-A-L			1/3 H + 1/4 A	2/3 H + 1/4 A or 1/3H + 2/4 A	1/3 H + 1/4 A	1/3 H + 1/4 A + 1/3 L
S2: H-A-I	1/3 H	1/3 H				2/3 H + 1/4 A
S3: H-a-L			2/3 H	3/3 H	1/3 H + 1/3 L	2/3 H + 1/3 L
S4: H-a-I						CD
S5: h-A-L	4/4 A + 3/3 L		1/3 L		1/4 A + 1/3 L	2/4 A + 1/3 L
S7: h-a-L	CD					2/3 L

most similarities between them is carried out. Then, the optimal SC for each range is selected.

Thus, the proposed break ranges for the new ETs could be: MBLOCA-I [2 - 3 inches], MBLOCA-II [3 - 12 inches], LBLOCA-I [12 - 25 inches] and LBLOCA-II [25 inches – DEGB]. A difference between the original ETs and these new ETs proposed can be found in the choice of splitting the range of each IE into two, as well as having considered the MBLOCA-II break size range up 12 inches.

The selection of SC for the MBLOCA-I and II ETs is straightforward, as there are no different SC for a single safety injection system. This is not the case for the LBLOCA, which presents several combinations of the SCs. For this second IE, it is proposed to consider the SCs in the following manner:

- For the LBLOCA-I ET, the minimum SC for the HPIS, 1 out of 3 trains, has been chosen at the expense of selecting the more restrictive HA SC, 2 out of 4, since the HA failure probability is lower (passive system) than that of HPIS (active system). Regarding the number of LPIS trains required, the results show that a single train is enough to avoid CD.

- For the LBLOCA-II ET, it is proposed that the SC for the LPIS and the HPIS is 2 out of 3 trains. The selected SC for the HA is 2 out of 4. This is because the sequences with 2 out of 3 HPIS trains and 1 out of 4 HA succeed by a small margin, less than 50 K (see Tables 8 and 10).

Considering the previous findings, the proposed ET for each IE are the following: The ET for the MBLOCA-I, Fig. 15, consists of the four original headers (S, H, A and L), while the MBLOCA-II ET, Fig. 16, dispenses with the A header as its actions are not required to avoid the CD. The proposed LBLOCA-I and LBLOCA-II ETs, Fig. 17, feature the original LBLOCA ET headers (H, A and L), with the success and failure sequences being the same for both, but with different SC, those of the LBLOCA-II being more restrictive than those of the LBLOCA-I.

6.2. LBLOCA expanded event trees approach

As discussed in Section 6.1, the selection of SC for the MBLOCA ETs is relatively straightforward, SC are unique for a single break

Table 10
Proposed success criteria for MBLOCA and LBLOCA sequences..

Sequence	BREAK SIZE			
	MBLOCA-I (2 in. - 3 in.)	MBLOCA-II (3 in. - 12 in.)	LBLOCA-I (12 in. - 25 in.)	LBLOCA-II (25 in. - DEGB)
S1: H-A-L	1/3 H or 4/4 A + 3/3L	1/3 H or 1/3 L	1/3 H + 2/4 A or 1/3 L	2/3 H + 2/4 A or 2/3 L
S2: H-A-I	1/3 H		1/3 H + 2/4 A	2/3H + 2/4 A
S3: H-a-L	1/3 H	1/3 H or 1/3 L	1/3 L	2/3 L
S4: H-a-I	1/3 H		CD	
S5: h-A-L	4/4 A + 3/3 L	1/3 L		2/3 L
S7: h-a-L	CD	1/3 L		2/3 L

MBLOCA-I (2 in. - 3 in.)	S	H	A	L	Nº	End State
	SCRAM	1/3 HPIS	1/2 HA-UP + 1/2 HA-DC	1/3 LPIS		

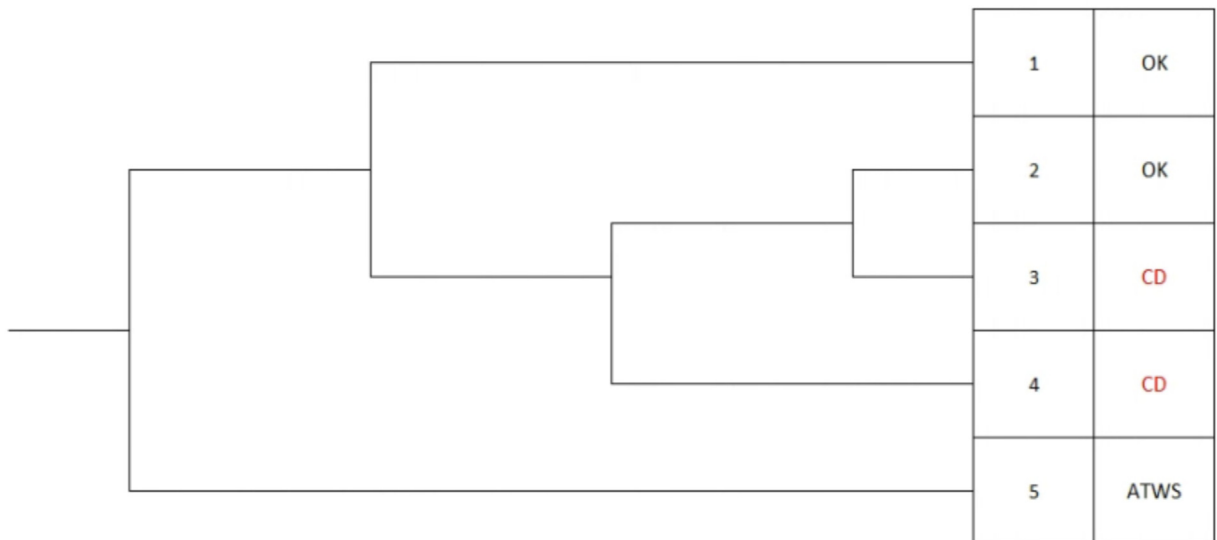

Fig. 15. Proposed MBLOCA-I sequences Event Tree.

size range, whereas for the LBLOCA there are several combinations of SC that lead to having to make a selection by choosing the most conservative one to propose new classic ETs. In this second

approach, the authors make use of the EETs [12], [10], in order to find a more realistic model for the LBLOCA sequences.

The difference between classic ETs and EETs is that whereas in

MBLOCA-II (3 in. - 12 in.)	S	H	L	Nº	End State
	SCRAM	1/3 HPIS	1/3 LPIS		

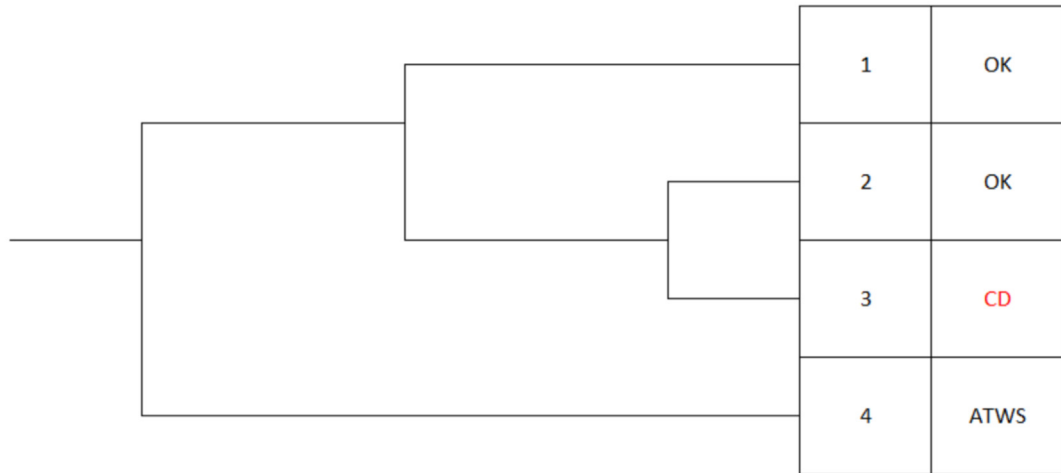

Fig. 16. Proposed MBLOCA-II sequences Event Tree.

LBLOCA-I (12 in. - 25 in.) / LBLOCA-II (25in. - DEGB)	H	A	L	Nº	End State
		1/2 HA-UP + 1/2 HA-DC			

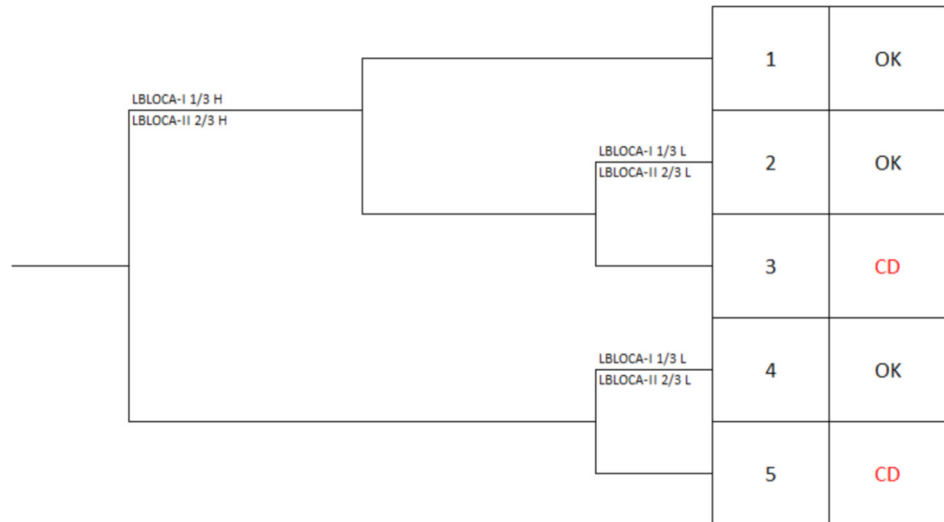

Fig. 17. Proposed LBLOCA-I and LBLOCA-II sequences Event Tree.

the first one there are only two possible options for each header, i.e., success or failure [13], in the second one it is feasible to have more than one success configurations, which allow considering a wide range of sequences.

In addition, a relaxation of the grouping of the LBLOCA range could be done, so that four EETs are proposed instead of the two

selected in the proposal in Section 6.1, which are:

- LBLOCA-A EET (12 to 20 inches). The H header is the only one that needs to be expanded in three possible configurations: zero trains, one train and more than two trains, Fig. 18. As the HPIS train configuration becomes more relaxed, the intervention of

12 in. - 20 in.	H	A	L	Nº	End State
-----------------	---	---	---	----	-----------

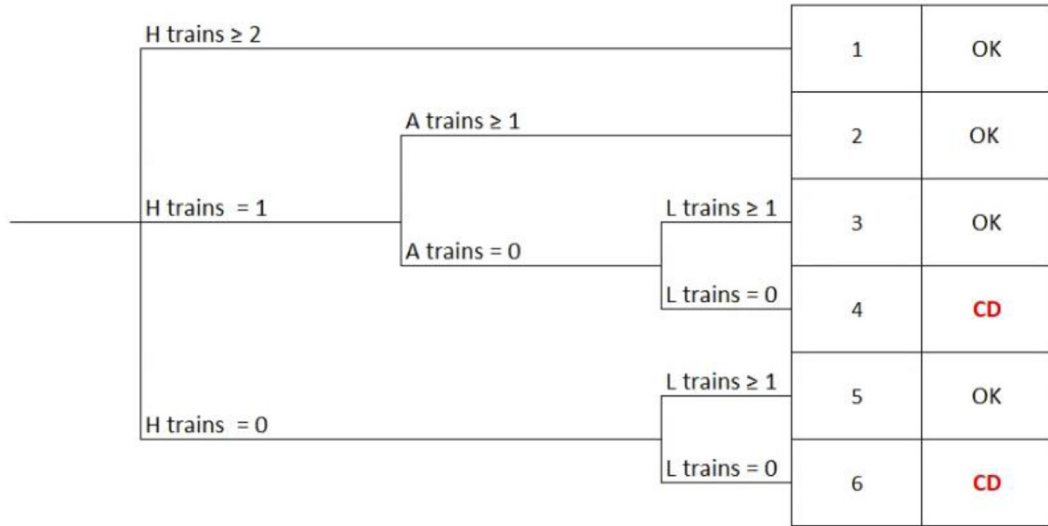

Fig. 18. LBLOCA-A expanded event tree.

20 in. - 25 in.	H	A	L	Nº	End State
-----------------	---	---	---	----	-----------

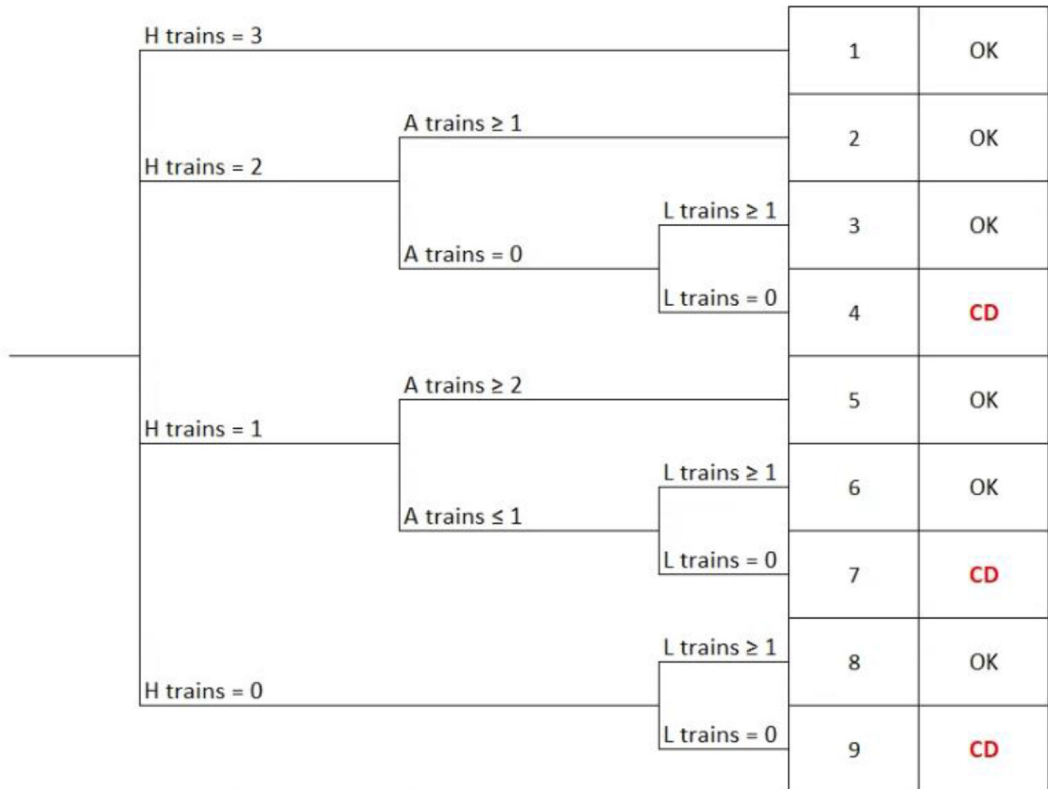

Fig. 19. LBLOCA-B expanded event tree.

25 in. - 30 in.	H	A	L	Nº	End State
-----------------	---	---	---	----	-----------

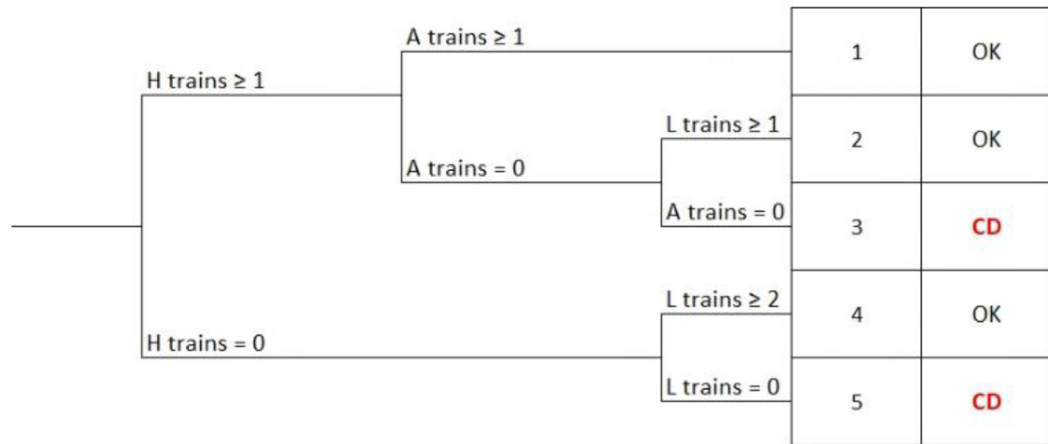

Fig. 20. LBLOCA-C expanded event tree.

30 in. - DEGB	H	A	L	Nº	End State
---------------	---	---	---	----	-----------



Fig. 21. LBLOCA-D expanded event trees.

other safety injections systems becomes necessary, so with the more than two trains configuration no other ECCS is required, however, for the 1 out of 3 HPIS trains configuration the successful injection of 1 out of 4 HA or 1 out of 3 LPIS trains is needed.

- LBLOCA-B EET (20 to 25 inches). Again, the only header expanded is the HPIS header, but in this case in four configurations: zero, one, two or three trains. All other headers are not expanded, Fig. 19. The only configuration that does not need the availability of other ECCS is 3 out of 3 HPIS trains the other configurations require the HA or the LPIS to inject successfully.
- LBLOCA-C EET (25 to 30 inches). This break size range that does not require the expansion of any of its headers, Fig. 20. With HPIS alone, it is not possible to avoid the CD, but with 1 out of 4 HA or 1 out of 3 LPIS trains successfully injecting all that is required is to successfully inject with one HPIS train.
- LBLOCA-D EET (30 inches to DEGB). In the EET it is again found that the H header must be expanded in three configurations: failure, one train and two or more trains, Fig. 21. For the configuration of two or more trains the injection of one HA is enough to achieve a successful end state, however, when the configuration is relaxed to 1 out of 3 HPIS trains, the successful injection of 1 out of 4 HA and 1 out of 3 LPIS trains or 2 out of 3 LPIS trains is required.

7. Conclusions

In this paper a re-assessment of the MBLOCA and LBLOCA ETs of the VVER-1000/V320 reactor has been performed. A TRACE5V5P5 TH model of the reactor has been developed including all safety systems. The SC of HPIS, LPIS and HAs have been assessed and confirmed; and to deepen into the sequence, all availability configurations have been simulated, which has provided the following insights:

- For LOCA break range between 2 and 12 inches the sole actuation of 1 out of 3 HPIS trains is enough to prevent core damage. But above 12 inches, 1 HPIS train is not enough and would need either HAs actuation or more HPIS/LPIS trains.
- LOCA break sizes above 3 inches and below 25 inches can avoid core damage with the successful actuation of one LPIS train.
- For LOCA break sizes over 20 inches, more than one SC appear for some headers.

Taking these findings into account, new proposals for the MB/LBLOCA ETs study have been developed:

- First, a reconfiguration of break sizes into four ranges allows using classic ETs and then four new ET are proposed.
- Second, if an EET approach is used, four EETs are proposed for the range from 12 inches to DEGB. Each of those EET have different SC for the different ECCS headers, supporting the aim of this work.

These new proposals could be taken into account in the PSA of current and future NPPs, helping to develop a more comprehensive and efficient evaluation of LOCA sequences.

Declaration of competing interest

The authors declare that they have no known competing financial interests or personal relationships that could have appeared to influence the work reported in this paper.

Acknowledgements

The authors have performed the work in the framework of the Grant PID2019-108755RB-I00 (ISASMORE) funded by MCIN/AEI/10.13039/501100011033.

References

- [1] Rosatom, Course on Technological Aspects of AES-2006 (VVER-1200). Development of Nuclear Curricula on VVER Technology, Rosatom, 2018. Obninsk, Russia.
- [2] T.H. Bui, C.T. Tran, Evaluation of VVER-1200/V491 reactor pressure vessel integrity during large break LOCA along with SBO using MELCOR 1.8.6, Nuclear Science and Technology 5 (4) (2015) 54–63. ISSN 1810-5408.
- [3] L. Sang-Won, H. Tae-Hyub, S. Mi-Ro, L. Young-Seung, K. Hyeong-Taek, Extended Station Blackout Coping Capabilities of APR1400, Science and Technology of Nuclear Installations, 2014, p. 10. Article ID 980418.
- [4] AREVA, "AREVA Design Control Document Rev. 1 - Tier 2 Chapter 06 - Engineered Safety Features - Section 6.3 Emergency Core Cooling System".
- [5] S. Chul-Hwa, P. Jong-Kyun, Thermal-hydraulic Experiments and the Evaluation of the New Safety Features in the APR1400, 2004. IAEA-CN-114/E-8.
- [6] M. Gavrilas, P. Hejzlar, N.E. Todreas, Y. Shatilla, Safety Features of Operating Light Water Reactors of Western Design, CRC, 1995.
- [7] General Nuclear System, Pre-Construction Safety Report. Chapter 7. Safety Systems, 24 December, 2021. HPR/GDA/PCSR/0007.
- [8] X. Huang, W. Zong, T. Wang, Z. Lin, Z. Ren, C. Lin, Y. Yin, Study on typical design basis conditions of HPR1000 with nuclear safety analysis code ATHLET, Frontiers in Energy Research (2020), <https://doi.org/10.3389/fenrg.2020.00127>.
- [9] Z. Kovacs, Probability Safety Assessment of WWER440 Reactors, Springer, 2014.
- [10] C. Queral, K. Fernández-Cosials, E. Zugazagoitia, C. Paris, J. Magan, R. Mendizabal, J. Posada, Application of Expanded Event Trees combined with uncertainty analysis methodologies, Reliability Engineering & System Safety 205 (2021), 107246.
- [11] A. Najafi, A. Shahsavand, S.A. Hosseini, A.S. Shirani, F. Yousefpour, K. Karimi, Transformation of classical PSA and DSA into the form of conditional event tree: an approach of human action in time dependent core damage risk, Annals of Nuclear Energy 165 (2022), 108662.
- [12] C. Queral, J. Montero-Mayorga, J. Rivas-Lewicky, M. Rebollo, Verification of AP1000 low margin PRA sequences based on best-estimated calculations, Annals Nuclear Energy 111 (December 2016) 98, 90.
- [13] J. Sánchez-Torrijos, C. Queral, C. París, M.J. Rebollo, M. Sánchez-Perea, J.M. Posada, Risk-Informed analysis using a new approach based on time-dependent success criteria. Application to LONF-ATWS sequences in PWR reactors, Nuclear Engineering and Technology (2022), <https://doi.org/10.1016/j.net.2022.08.019>. In press.
- [14] S.A. Hosseini, A.S. Shirani, M. Zangian, A. Najafi, Re-assessment of accumulators performance to identify VVER-1000 vulnerabilities against various break sizes of SB-LOCA along with SBO, Progress in Nuclear Energy 119 (2020), 103145.
- [15] L. Sabotinov, A. Srivastava, Large break Loss of coolant accident analysis of VVER-1000 reactor using CATHARE code, in: Congress on Advances in Nuclear Power Plants (ICAPP '08), Anaheim, CA USA, June 8-12, 2008.
- [16] A. Dina, S. Nikonov, A. Travleev, The first circuit of VVER-1000 and the most dangerous places of LBLOCA as a source of dynamic load on the equipment, in: 11th International Scientific and Technical Conference Safety Assurance of NPP with VVER., Podolsk, Russia, May 21-24, 2019.
- [17] L. Sabotinov, S. Lutsanych, I. Kadenko, Primary LOCA in VVER-1000 by pressurizer PORV failure, in: Bulgarian Nuclear Society International Conference "Nuclear Energy in Europe - Present and Future", Bulgaria, September 18-21, 2013.
- [18] M. Tarantino, F. D'Auria, G. Galassi, Simulation of a large break LOCA on VVER-1000 NPP by RELAP5/MOD3.2 code, in: ANS/HPS Student Conference, Texas, US, March 29-31, 2001.
- [19] IAEA, Fuel behaviour under transient and LOCA conditions, in: Proceedings of a Technical Committee Meeting, Halden, Norway, 10-14 September, 2001.
- [20] OECD, Validation matrix for the assessment of thermal-hydraulic codes for LOCA and transients. A report by the OECD support group on the VVER thermal-hydraulic code validation matrix. JT00108841, in: NEA/CSNI/R(2001) 4, 01 June, 2001.
- [21] Federal Environmental, Industrial and Nuclear Supervision Service of Russia (Rostekhnadzor) with support from the U.S. Nuclear Regulatory Commission, Kalinin VVER-1000 nuclear power station unit 1 PRA (beta project), NUREG/IA-0212 1 (November 2005).
- [22] A. Hossain-Khan, M.I. Al-Imran, N. Fyza, M. Sarkar, A numerical study on the transient response of VVER-1200 plant Parameters during a large-break Loss of coolant accident, Indian Journal of Science and Technology 12 (27) (July, 2019).
- [23] F. Gibson-Daud-Thulu, A. Elshahat, M.H.M. Hassan, Simulation of VVER-1000 guillotine large break Loss of coolant accident using RELAP5/SCDAPSIM/MOD3.5, Journal of Nuclear Engineering 2 (2021) 516–532.

- [24] S.K. Mousavian, F. D'Auria, G. Galassi, A. Petruzzi, M. Salehi, Uncertainty analysis of LB-LOCA in VVER-1000 geometry, in: International Conference Nuclear Energy for New Europe 2003, Portoroz, Slovenia, September 8-11, 2003.
- [25] S. Iegan, A. Mazur, Y. Vorobyov, O. Zhabin, S. Yanovskiy, TRACE VVER-1000/V320 Model Validation, 2018. NUREG/IA-0490.
- [26] C. Queral, V.H. Sánchez-Espinoza, D. Egelkraut, K. Fernández-Cosials, E. Redondo-Valero, A. García-Morillo, Safety systems of GEN-III/GEN-III+ VVER reactors, Nuclear España (October 2021). <https://www.revistanuclear.es/wp-content/uploads/2021/10/Art.seguridad-reactores.pdf>.
- [27] В.И. Скалозубов, А.А. Ключников, В.Н. Колыханов, Fundamentals of Management of Design Accidents with Loss of Coolant at the Power Plant, 2010.
- [28] NRC, TRACE V5.840, User's Manual: Input Specification, 2017.
- [29] V. Sanchez-Espinoza, M. Bottcher, Investigations of the VVER-1000 coolant transient benchmark phase with the coupled system code RELAP5/PARCS, Progress in Nuclear Energy 48 (2006).
- [30] S. Iegan, A. Mazur, Y. Vorobyov, O. Zhabin, S. Yanovskiy, TRACE/RELAP5 Comparative Calculations for Double-Ended LBLOCA and SBO, November 2016. NUREG/IA-0475.
- [31] N. Kolev, N. Petrov, J. Donovan, D. Angelova, S. Aniel, E. Royer, K. Ivanov, E. Lukanov, Y. Dinkov, D. Popov, S. Nikonov, VVER-1000 Coolant Transient Benchmark - Phase 2 (V1000CT-2). Vol. 11: MSLB Problem - Final Specifications, April, 2006. NEA/NSC/DOC(2006)6.
- [32] C. Queral, J. Gómez-Magán, C. París, J. Rivas-Lewicky, M. Sánchez-Perea, J. Gil, J. Mula, E. Meléndez, J. Hortal, J. Izquierdo, I. Fernández, Dynamic event trees without success criteria for full spectrum LOCA sequences applying the integrated safety assessment (ISA) methodology, Reliability Engineering and System Safety 171 (2018) 152–168.